

0 489 41/44

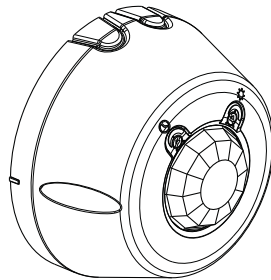

0 489 48

CONTENTS

Page

1. Use	1
2. Technical features	1
3. Overall dimensions	2
4. Connection	2
5. Installation	3
6. Settings	4
7. Performance	4
8. Maintenance	4
9. Standards and approvals	4

1. USE

This device enables a light source to be controlled automatically by detecting movement in the monitoring area. Using infrared (IR) technology, this motion sensor has a 360° detection angle and, when positioned 2.50 m above the ground, an 8 m diameter detection area. It is installed on false ceiling (0 489 41/44 or surface ceiling (0 489 48). It is quick and easy to set, using potentiometers. The light level threshold can vary from 10 to 1275 lux and the time delay from 10 seconds to 10 minutes.

2. TECHNICAL FEATURES

Voltage: 240 V~
 Frequency: 50/60 Hz
 Consumption on standby: 0.75 W
 Output via normally open contact connected to the phase
 Wiring: 1 x 2.5 mm²/2 x 1.5 mm²
 Number of terminals: 3
 Type of terminal: screw
 Drilling diameter for installation in false ceiling: 65 mm
 Weight: 71 g
 Impact resistance: IK04
 Penetration by solid and liquid matter: 0 489 41/44 IP20 (unmounted)
 0 489 41/44 IP41 (monted)
 0 489 48 IP20

Usage temperature: -5°C to +45°C
 Storage temperature: -20°C to +70°C

2. TECHNICAL FEATURES (continued)

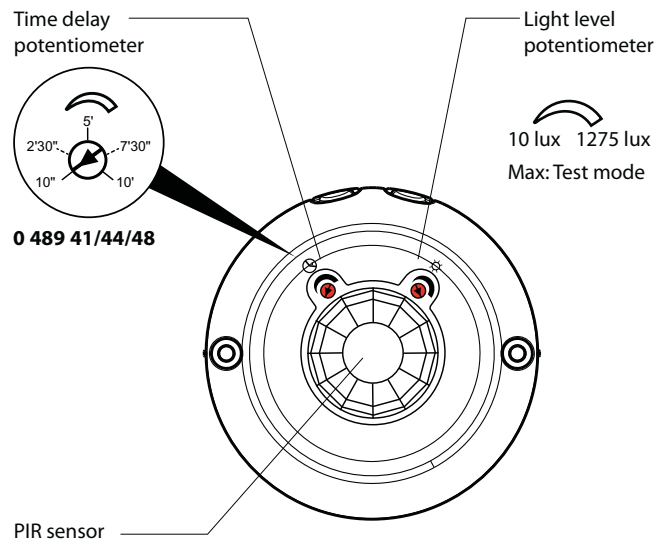

0 489 41/44/48

	①	②	③	④	⑤
230 V~					
	1000 W	500 VA	5 x (2x36 W)	250 VA	500 VA
	4.3 A	2.1 A	2.1 A	1.1 A	2.1 A
	⑥	⑦	⑧	⑨	⑩
230 V~					
	5 x (2x36 W)	250 W	250 VA	250 VA	250 W
	2.1 A	1.1 A	1.1 A	1.1 A	1.1 A

- 1 - Halogen bulbs
- 2 - ELV halogen bulbs with separate ferromagnetic ballast
- 3 - Fluorescent tubes with separate ferromagnetic ballast
- 4 - Compact fluorescent bulbs with separate ferromagnetic ballast
- 5 - ELV halogen bulbs with separate electronic ballast
- 6 - Fluorescent tubes with separate electronic ballast
- 7 - Compact fluorescent bulbs with built-in electronic ballast
- 8 - Compact fluorescent bulbs with separate electronic ballast
- 9 - LED bulbs with separate electronic ballast
- 10 - LED bulbs with built-in electronic ballast

3. OVERALL DIMENSIONS

0 489 41/44

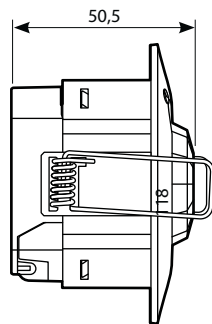
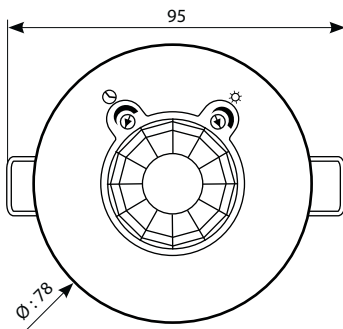

0 489 48

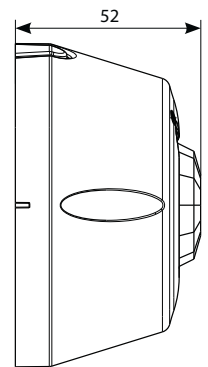
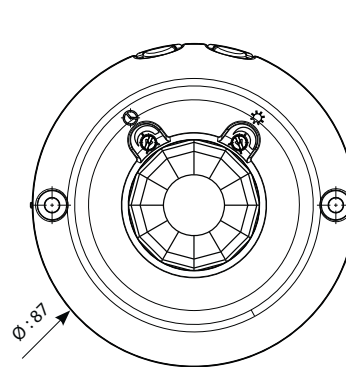

4. CONNECTION

■ 4.1 Wiring without auxiliary control:

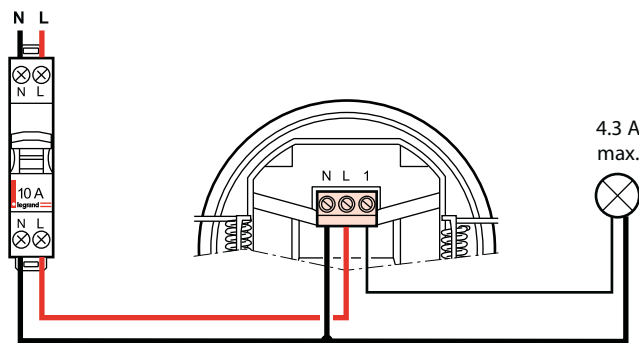

■ 4.2 Wiring for a single load connected in parallel

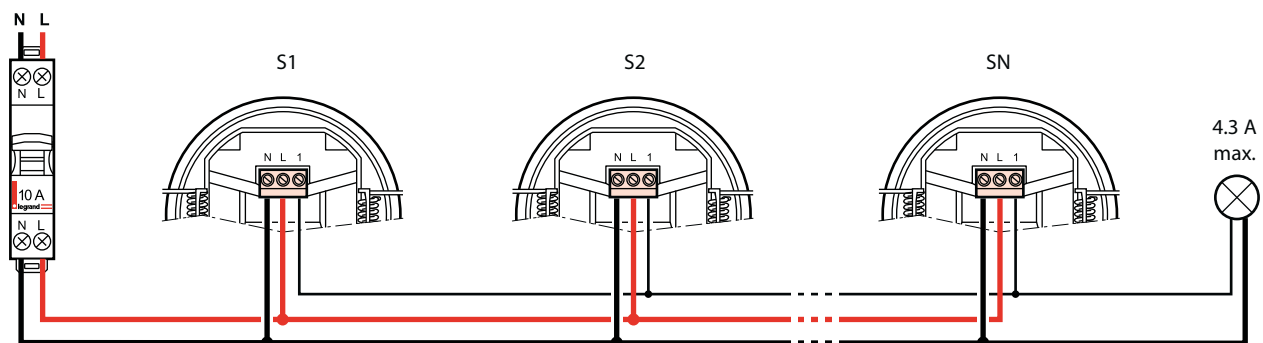

5. INSTALLATION

■ 5.1 Positioning the sensor

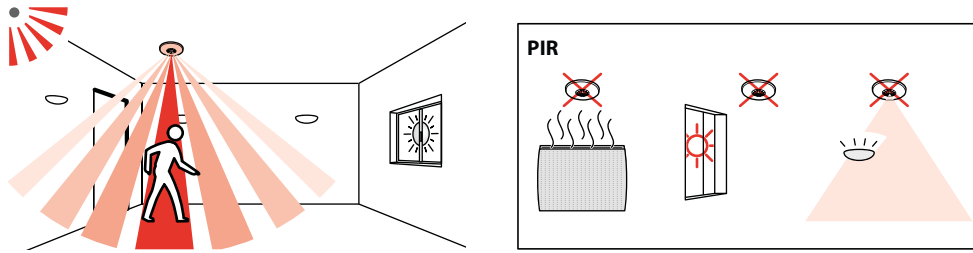

■ 5.2 Positioning

0 489 41/44

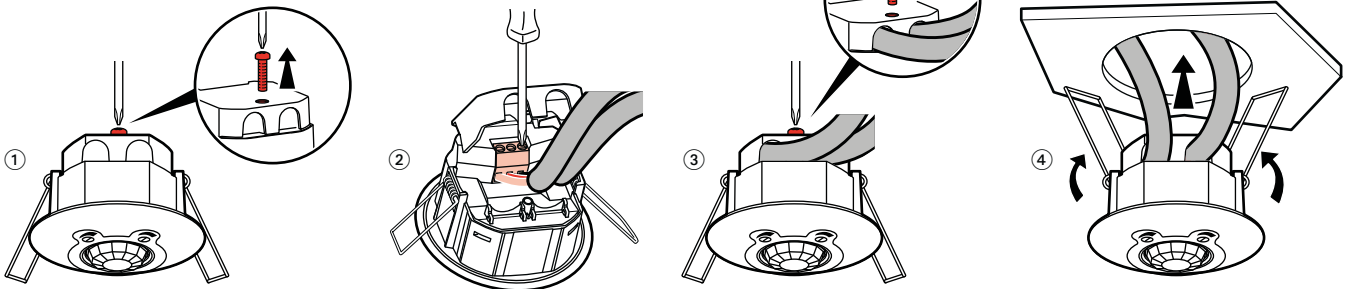
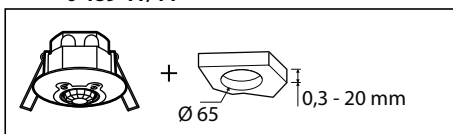

0 489 48

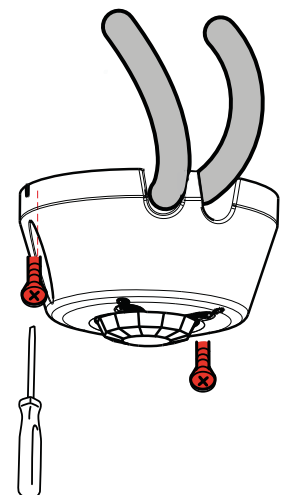
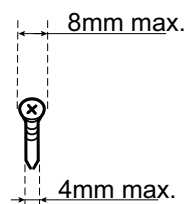
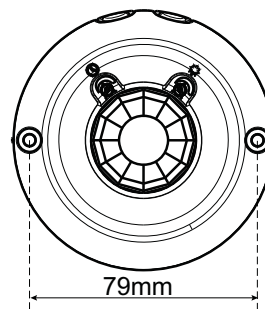
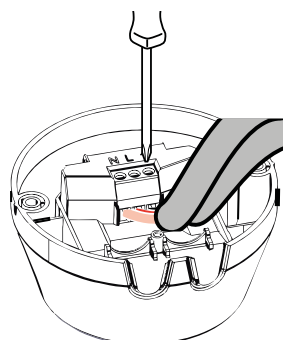
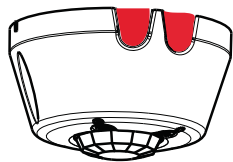

6. SETTING

■ **6.1 Time delay parameter**

Sensor parameter	Default value	Modifiable parameters
Time delay	Min.	10 sec to 10 min

⌚ **Time delay:** Length of time the load remains on after detection.

■ **6.2 Light level parameter**

Sensor parameter	Default value	Modifiable parameters
Light level threshold	Max.	10 to 1275 lux

☀ **Light level threshold:** Value at which the load switches on if the natural light level is below the setting.

■ **6.3 Detection**

Automatic switch-on:
 - On detection of presence, if there is an insufficient natural light level.
 Automatic switch-off:
 - If no presence is detected and at the end of the set time delay.
 Any new detection triggers automatic switch-on if there is insufficient light.

7. PERFORMANCE

■ **7.1 Tangential movement**

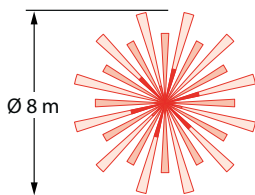
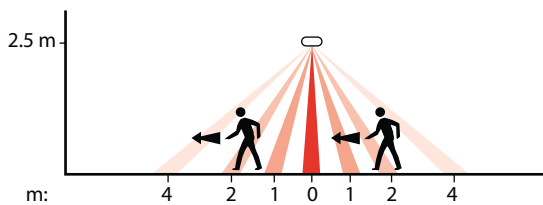

■ **7.2 Radial movement**

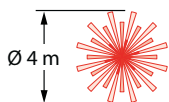
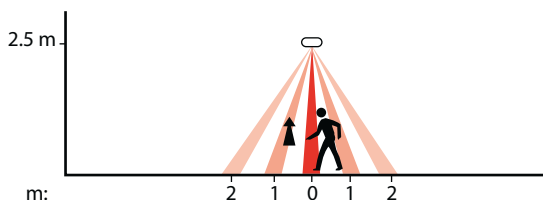

8. MAINTENANCE

Keep the lens clean.
 Clean the surface with a cloth.
 Do not use: acetone, tar-removing cleaning agents or trichloroethylene.
 Maintenance with the following products: - Hexane (En 60669-1)
 - Methylated spirit
 - Soapy water
 - Diluted ammonia
 - Bleach diluted to 10%
 - Window cleaning products

Attention:

Always test before using other special cleaning products.

9. STANDARDS

Directive: CE
 Product standards: IEC 60669-2-1
 Environmental standards:
 - EU Directive 2002/96/EC:
 WEEE (Waste Electrical and Electronic Equipment)
 - EU Directive 2002/95/EC:
 RoHS (Restriction of Hazardous Substances)

Note:

All technical information is available at

