

+ 0 590 56

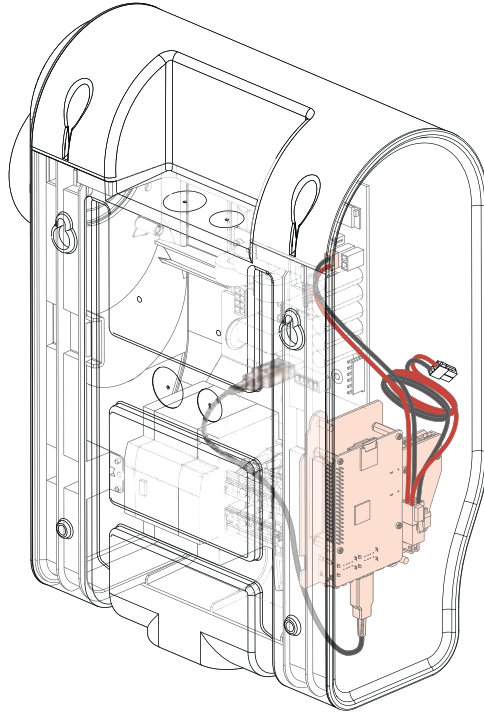

(FR) / (EN)

(ES) / (PT)

(IT) / (FL)

(DE)

0 590 56

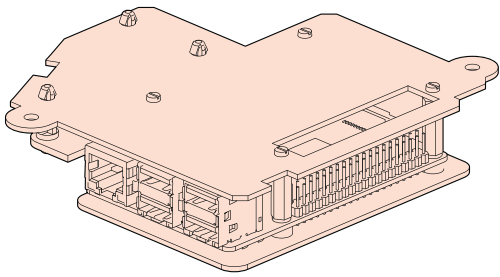

0 590 59

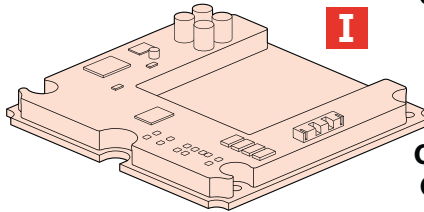

Ou/Or  
O/Ou  
O/Of  
Oder

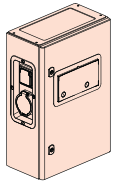
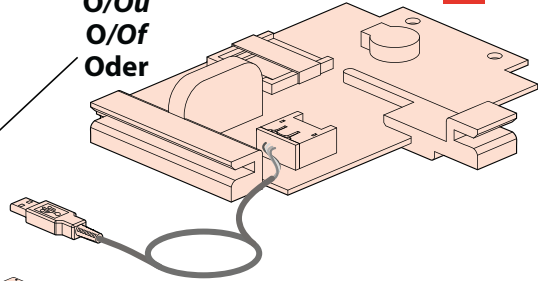

+

0 590 56

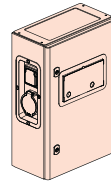

+

0 590 56

+

0 590 59

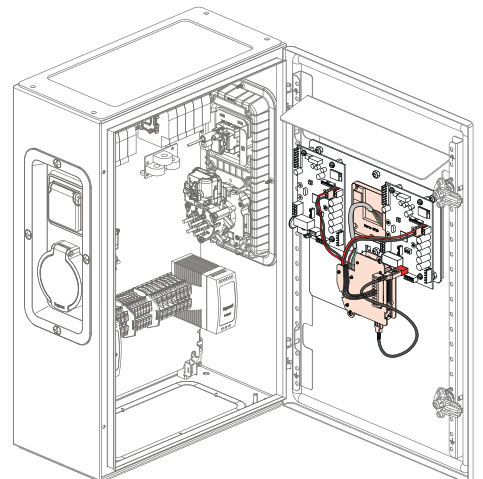
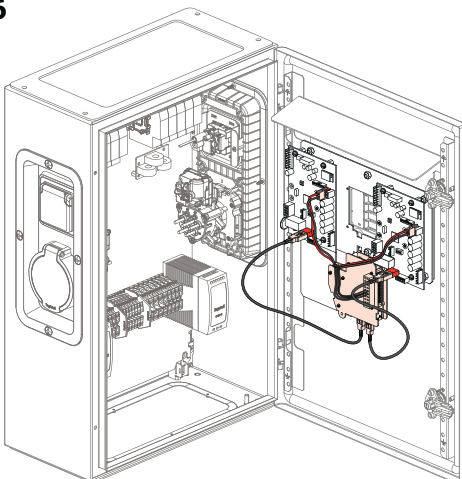



 **Consignes de sécurité / Safety instructions**

 **DEEE**



Configuration accès pages WEB ..... p 16  
 Configuration of access to Web pages ..... p 16

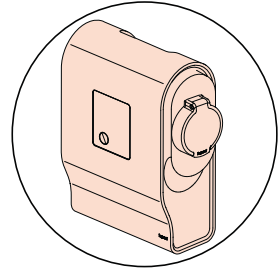

Installation/Installation  
 0 590 56 ..... p 2

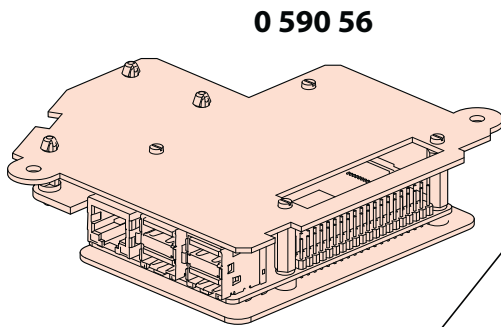

**0 590 56**

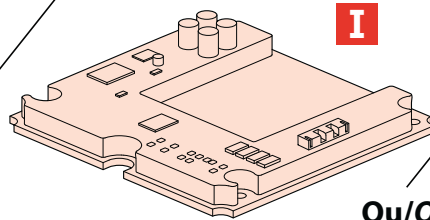

**0 590 59**

**Ou/Or**

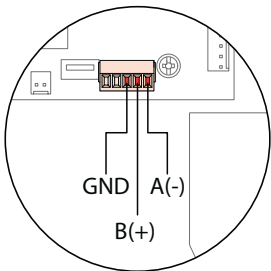
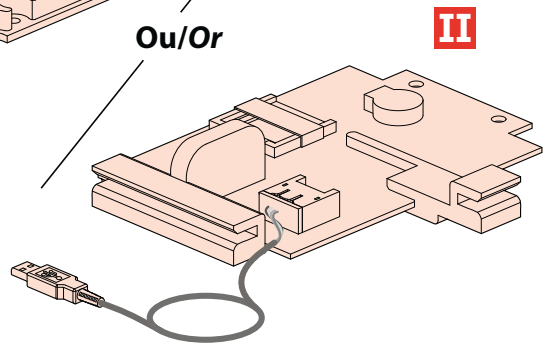

Raccordement  
 connectique ..... p 14  
 Connecting  
 the connectors ..... p 14

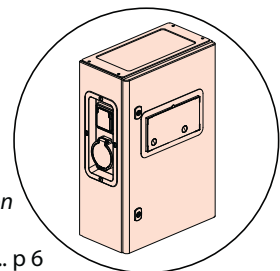

Installation/Installation  
 0 590 56 ou/or  
 0 590 56 + 0 590 59 ..... p 6



0 590 56

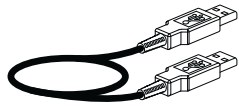
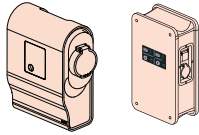

x 2

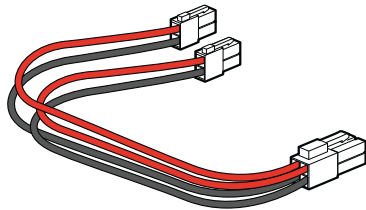
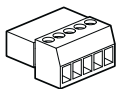
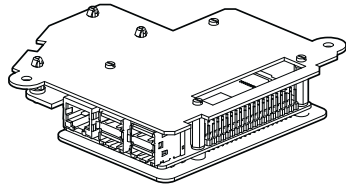

M4 x 7  
x 2

4 x 12  
x 2

0 590 59

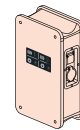

I

Ou/Or

II



x 4

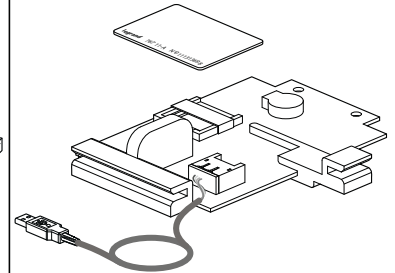
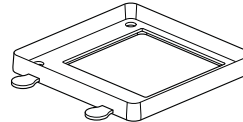
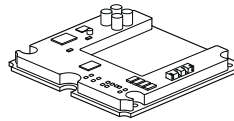
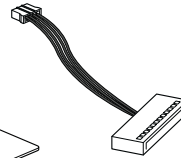

**Avant toute intervention, couper le courant.**  
**Respecter strictement les conditions d'installation et d'utilisation.**  
**Make sure the power supply is disconnected before starting work.**  
**Comply strictly with the instructions for installation and use.**

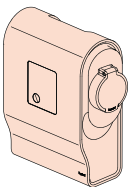

+ 0 590 56

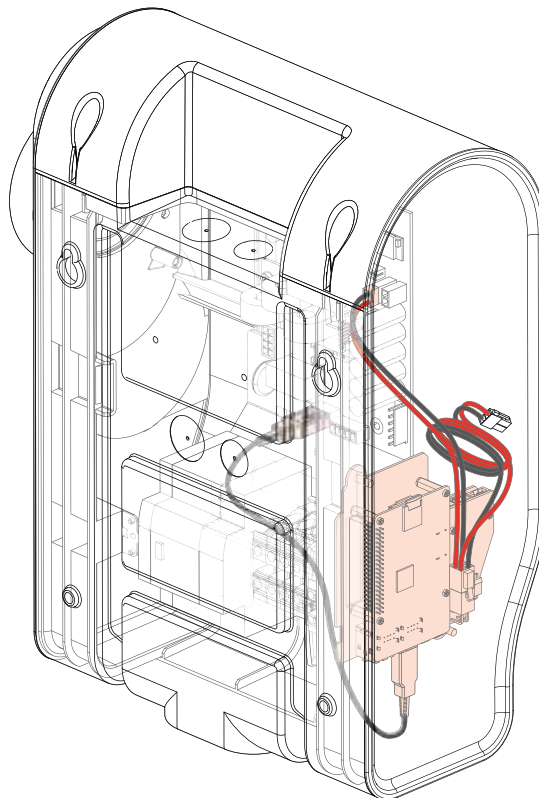



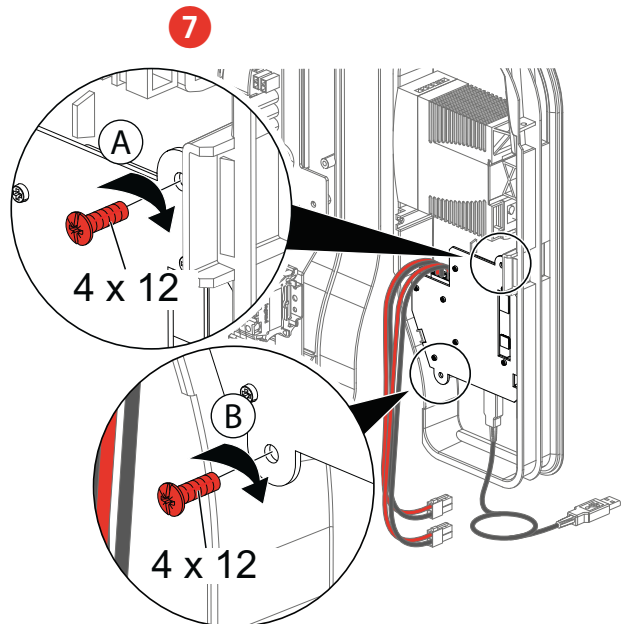
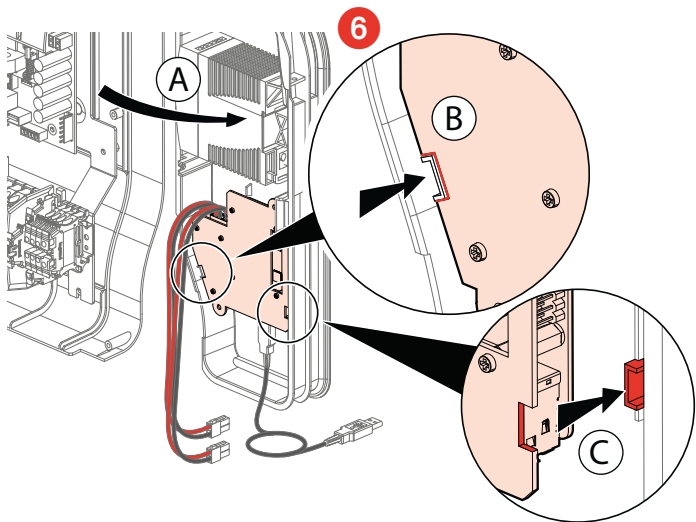
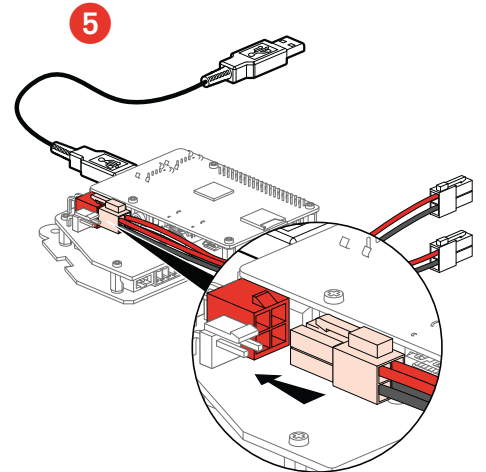
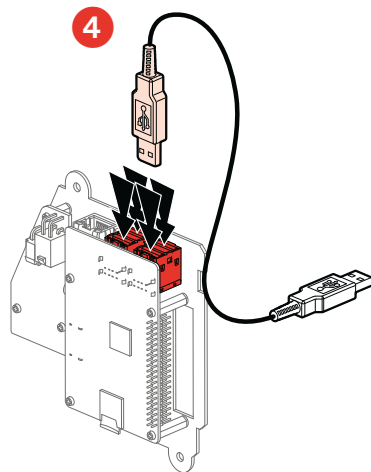
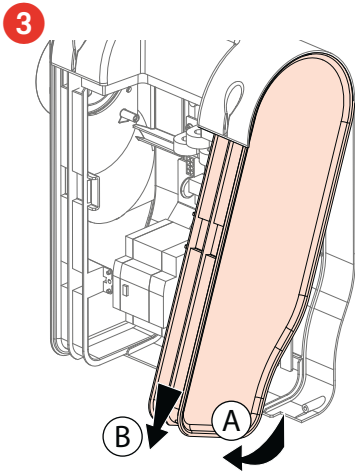
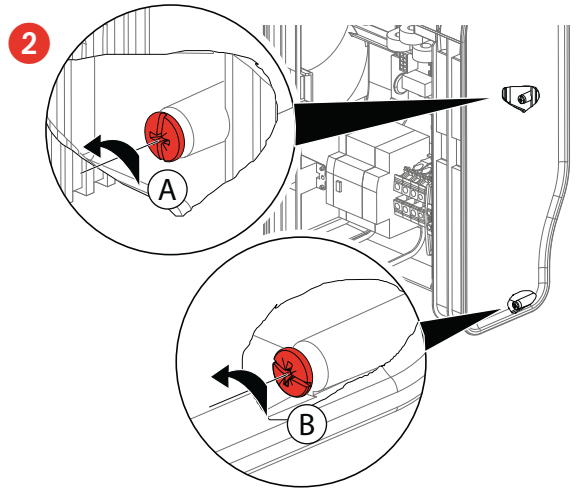
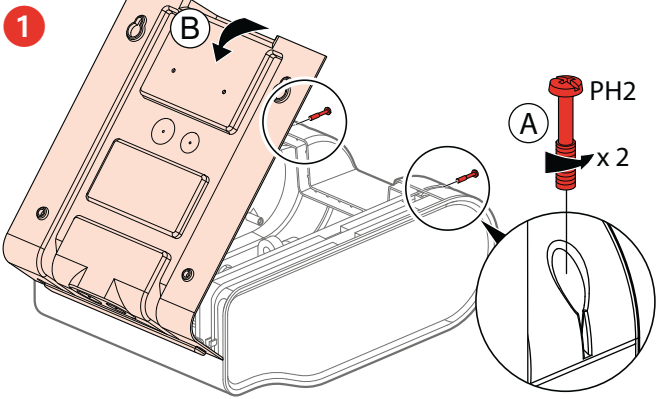

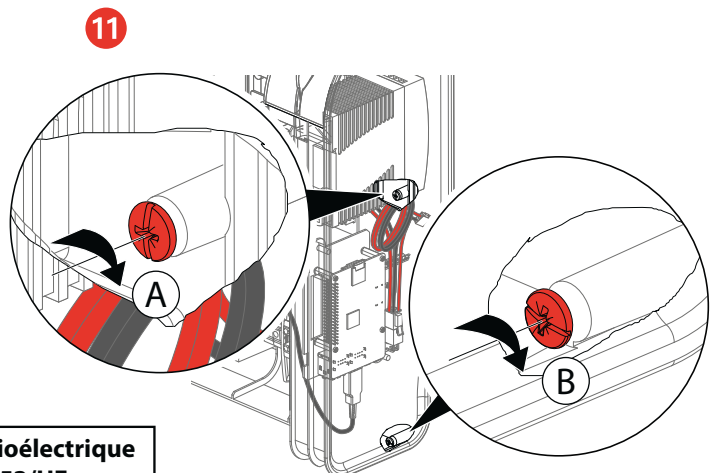
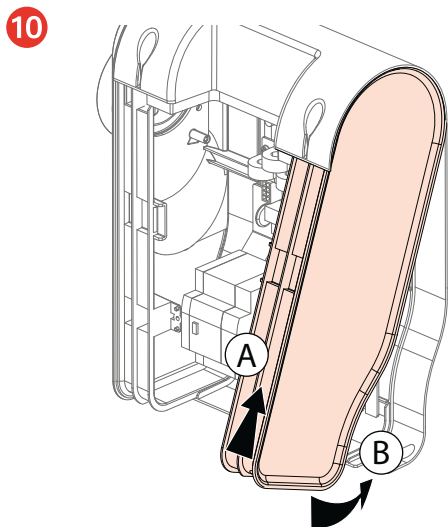
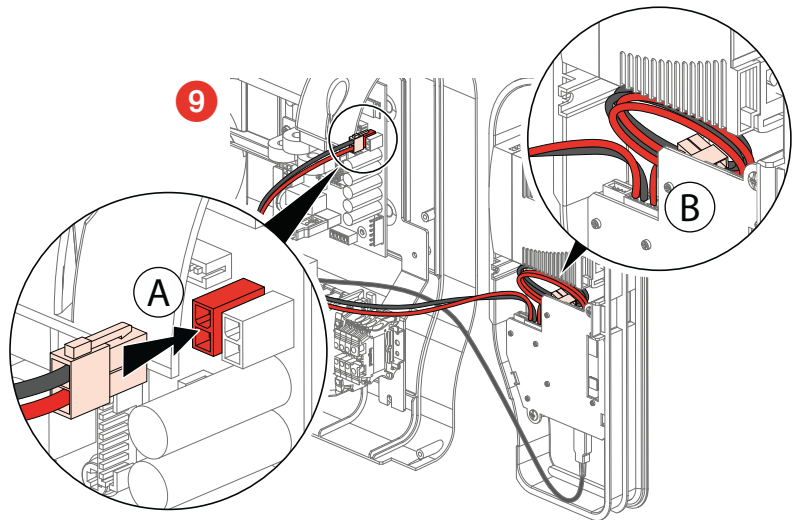
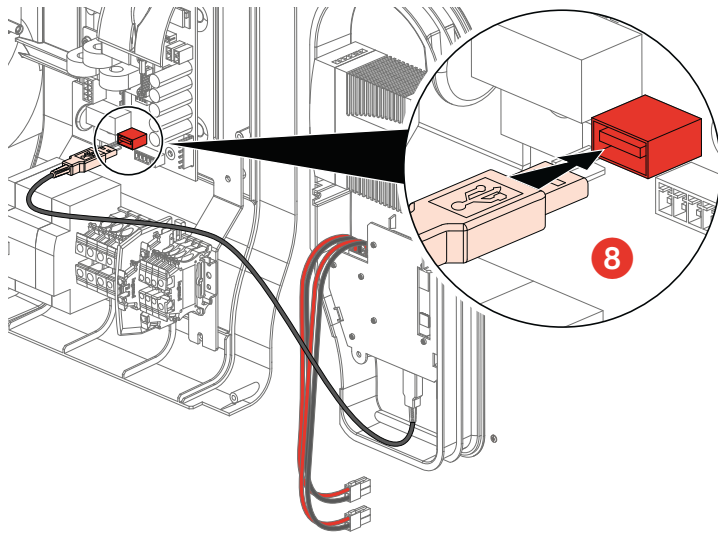

Le soussigné, LEGRAND, déclare que l'équipement radioélectrique du type (0 590 56/59) est conforme à la directive 2014/53/UE. Le texte complet de la déclaration UE de conformité est disponible à l'adresse suivante : [www.legrand.com](http://www.legrand.com)

The undersigned, LEGRAND, declares that radio equipment of type (0 590 56/59) complies with the Directive 2014/53/EU. The full text of the EU declaration of conformity can be found at: [www.legrand.com](http://www.legrand.com)

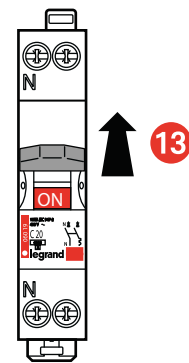
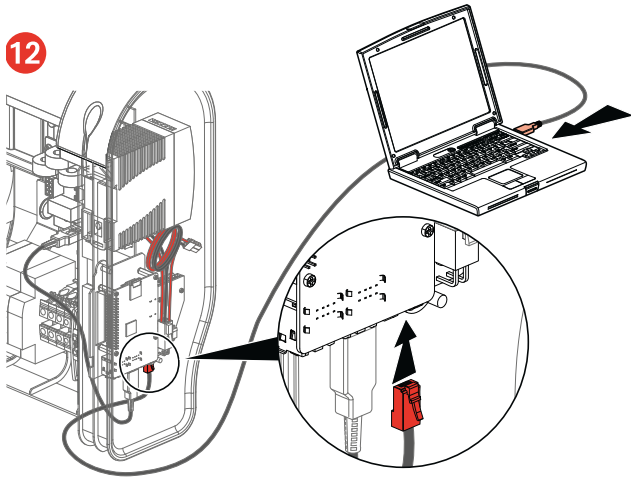

- 14** Après raccordement du kit de communication, une mise à jour de votre borne de charge va s'effectuer. A la mise sous tension, merci de patienter environ 3 minutes avant toute manipulation/configuration. Chaque côté de votre borne de charge effectuera automatiquement 2 re-démarrages pendant ce processus.  
*Once the communication kit has been connected, your charging station will update itself. On powering up, please wait at least 3 minutes before any configuration or other work. During this time, each side of your charging station will automatically restart twice.*



Initialisation de la borne  
*Initialising the charging station*

Voyant défilement blanc puis voyant blanc fixe  
*White scrolling indicator and then steady white indicator*  
 Attendre le redémarrage de la borne puis  
*Wait for the charging station to restart, and then*

**Nota : pour configuration, voir page 16**  
**Note: For configuration, see page 16**



Voyant blanc fixe OK  
*Steady white indicator OK*

- 15** Entrées de câbles pour raccordement filaire (RJ45), voir page 3 de la notice de votre borne de recharge n° LE09745AA  
*Cable inputs for wired connection (RJ45), see page 3 of your charging station's instruction sheet No. LE09745AA*

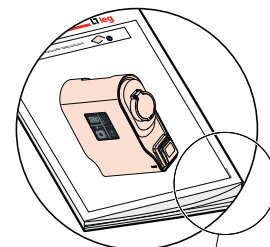

**LE09745AA**

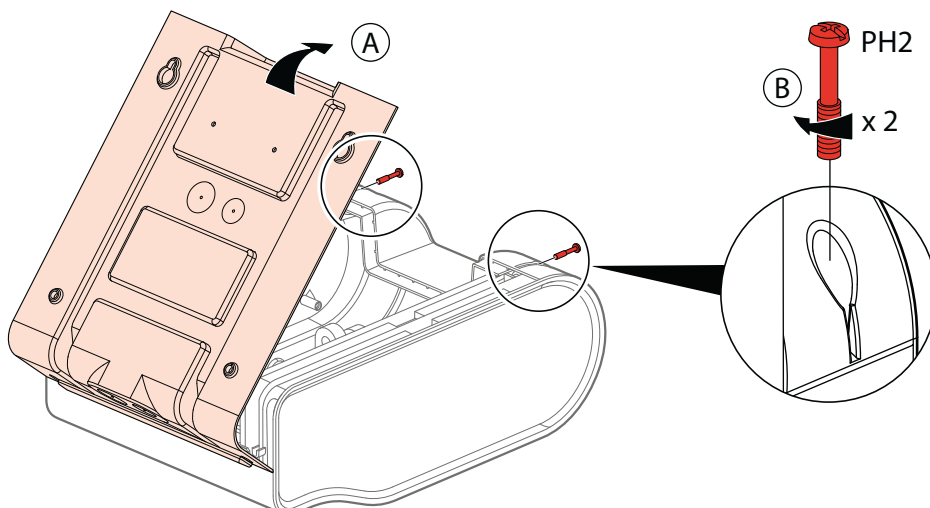



**Avant toute intervention, couper le courant.**  
**Respecter strictement les conditions d'installation et d'utilisation.**  
**Make sure the power supply is disconnected before starting work.**  
**Comply strictly with the instructions for installation and use.**

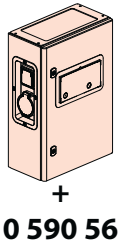

+  
**0 590 56**

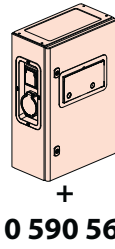
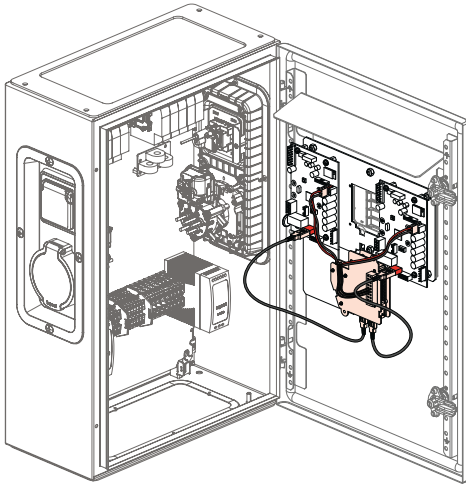

+  
**0 590 56**

+  
**0 590 59** **I**

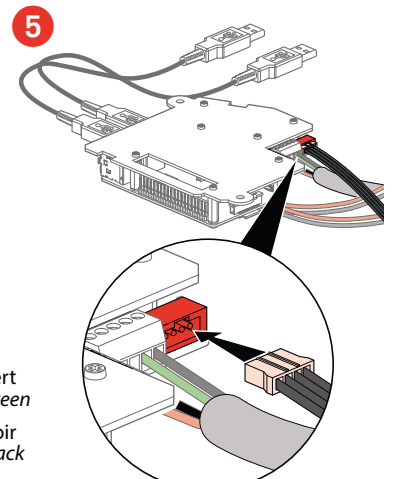
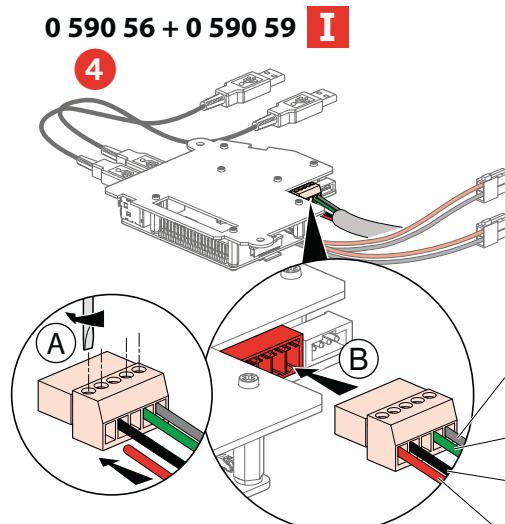
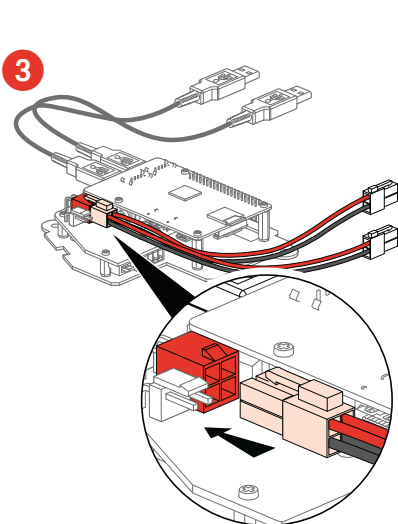
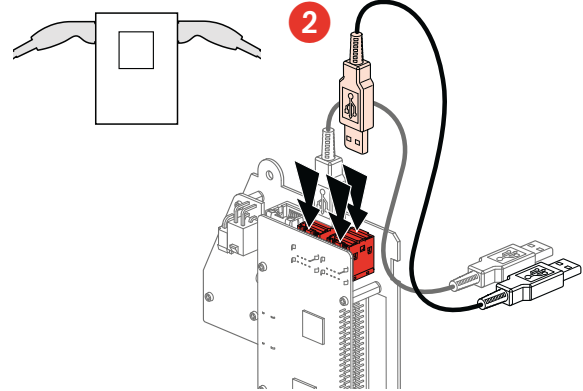
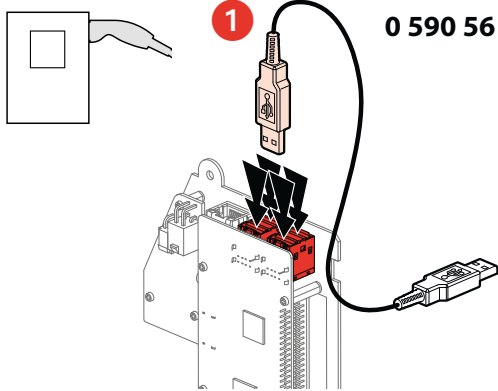
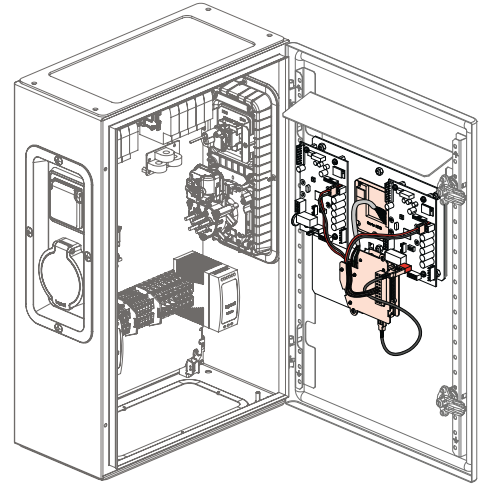

Gris  
Grey  
Vert  
Green  
Noir  
Black  
Rouge  
Red

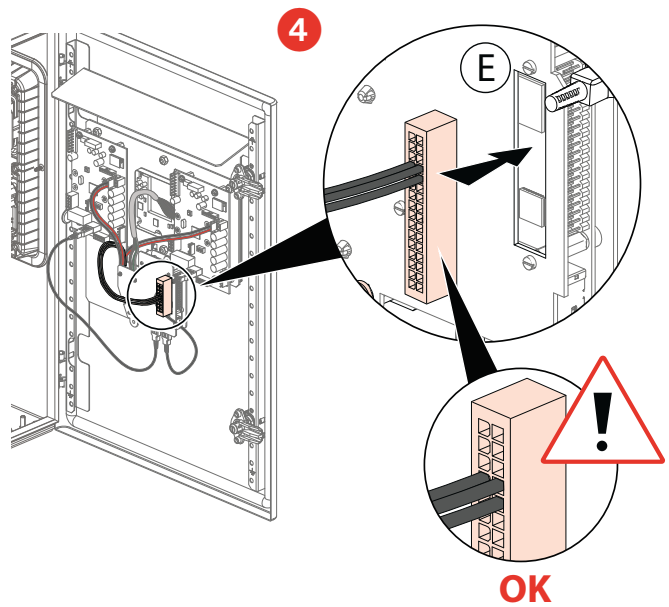
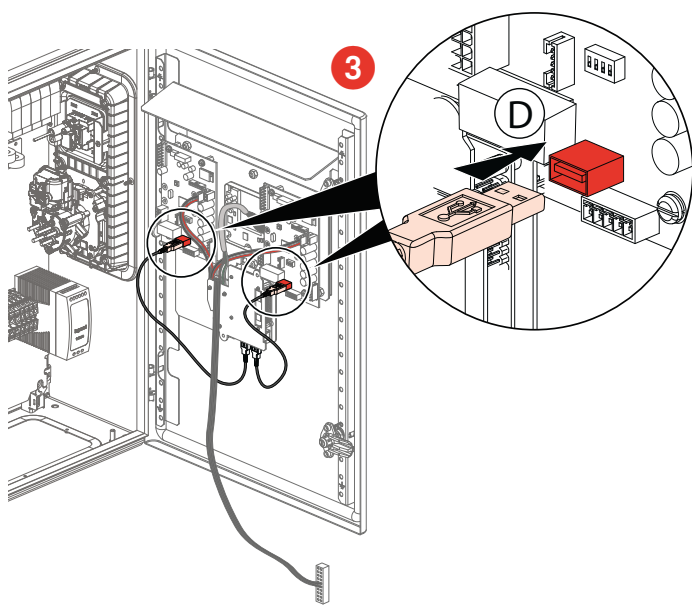
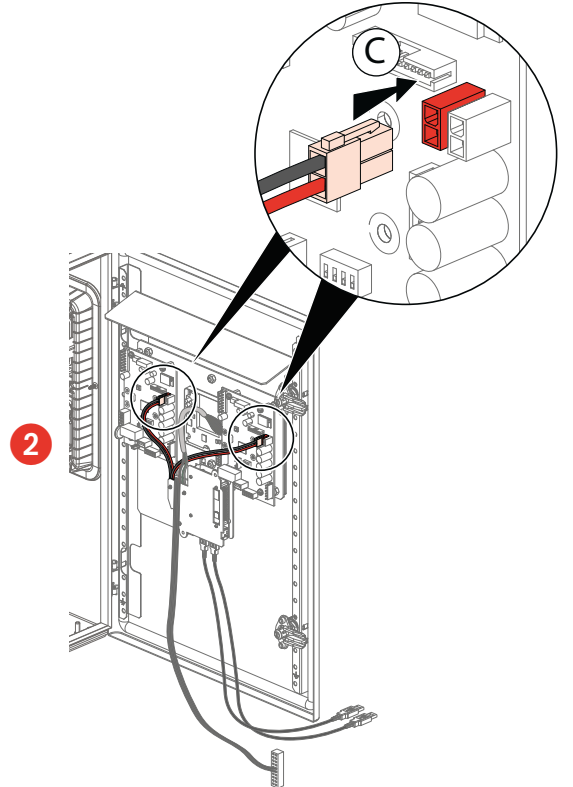
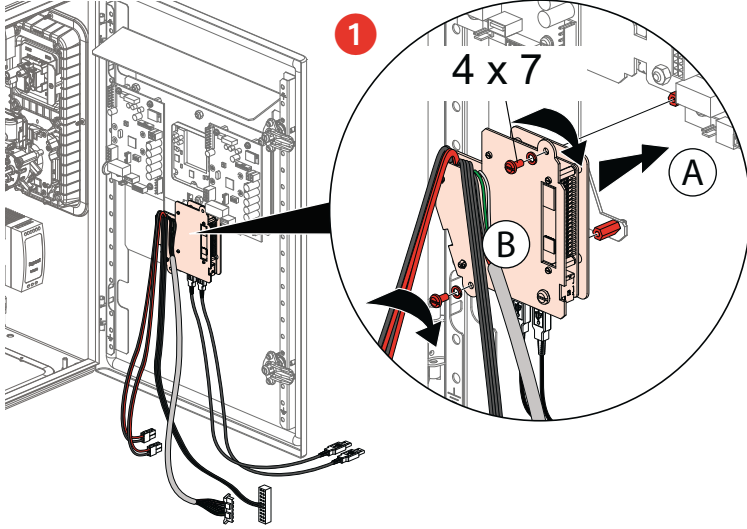



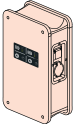

+ 0 590 59 **I**

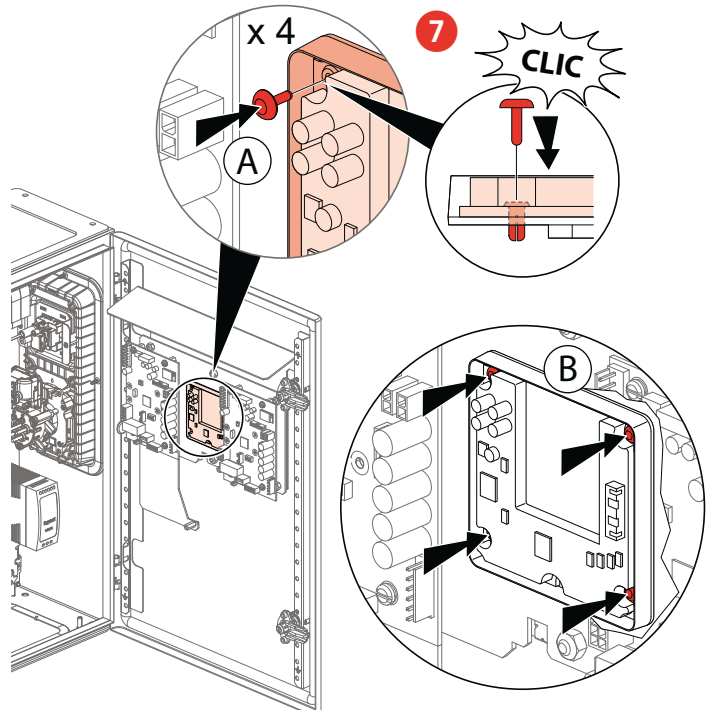
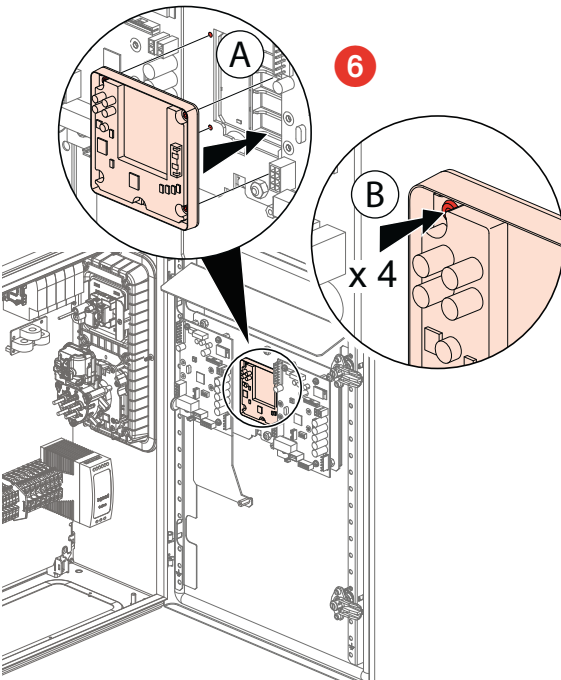
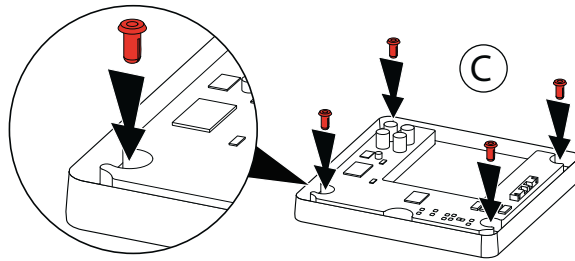
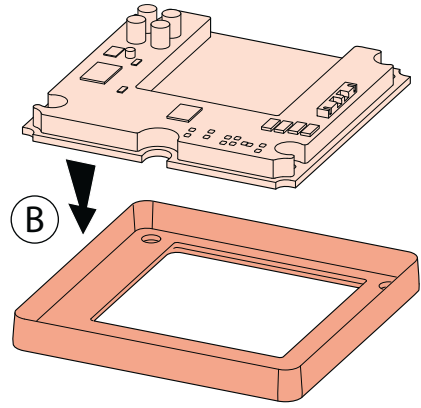
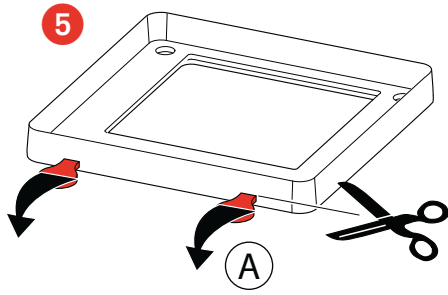

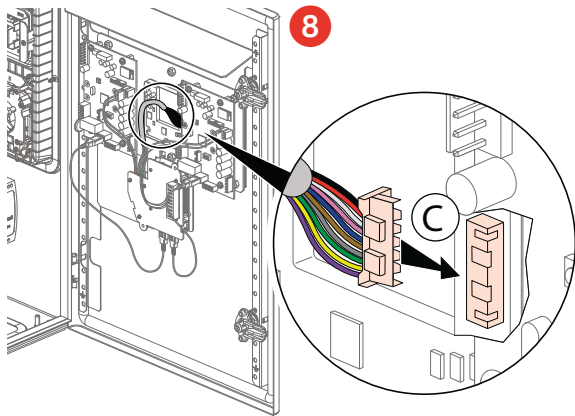

Le soussigné, LEGRAND, déclare que l'équipement radioélectrique du type (0 590 56/59) est conforme à la directive 2014/53/UE. Le texte complet de la déclaration UE de conformité est disponible à l'adresse suivante : [www.legrand.com](http://www.legrand.com)

The undersigned, LEGRAND, declares that radio equipment of type (0 590 56/59) complies with the Directive 2014/53/EU. The full text of the EU declaration of conformity can be found at: [www.legrand.com](http://www.legrand.com)

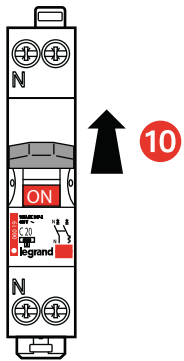
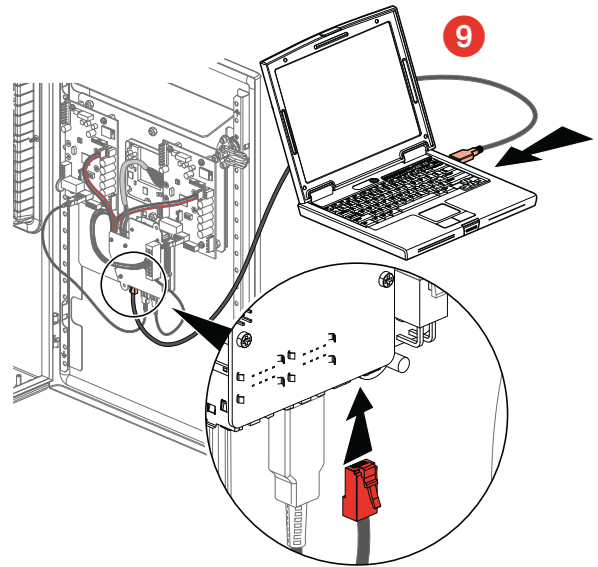

**11** Après raccordement du kit de communication, une mise à jour de votre borne de charge va s'effectuer. A la mise sous tension, merci de patienter environ 3 minutes avant toute manipulation/configuration. Chaque côté de votre borne de charge effectuera automatiquement 2 re-démarrage pendant ce processus.

*Once the communication kit has been connected, your charging station will update itself. On powering up, please wait at least 3 minutes before any configuration or other work. During this time, each side of your charging station will automatically restart twice.*



Initialisation de la borne  
*Initialising the charging station*

Voyant défilement blanc puis voyant blanc fixe  
Attendre le redémarrage de la borne puis  
*White scrolling indicator and then steady white indicator*  
Wait for the charging station to restart, and then



Voyant blanc fixe OK  
*Steady white indicator OK*

**12** Configuration, voir page 16  
*Configuration, see page 16*

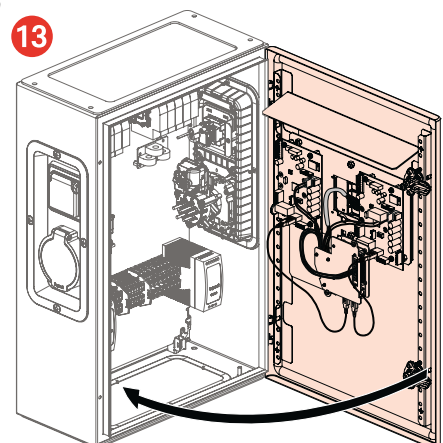



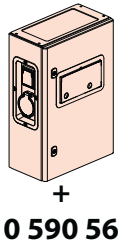

**Avant toute intervention, couper le courant.**  
**Respecter strictement les conditions d'installation et d'utilisation.**  
**Make sure the power supply is disconnected before starting work.**  
**Comply strictly with the instructions for installation and use.**



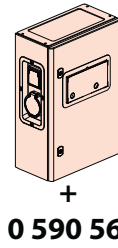
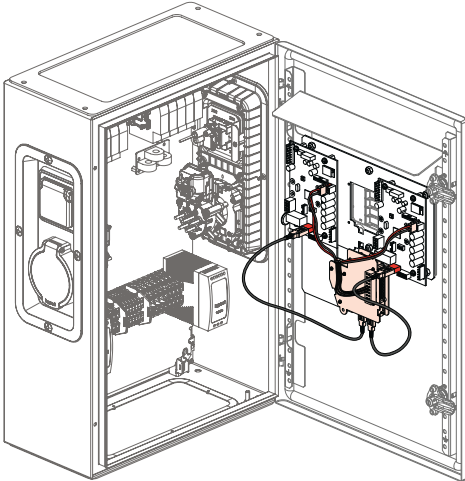

+  
**0 590 56**

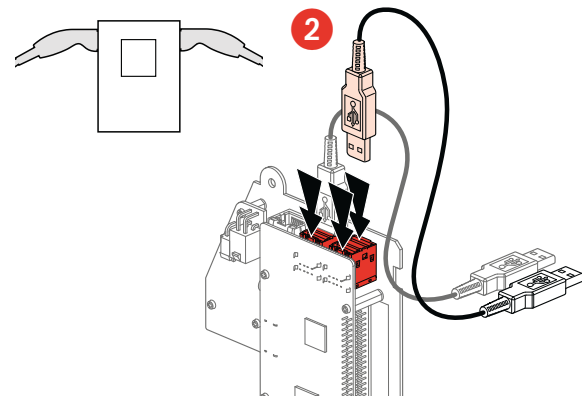
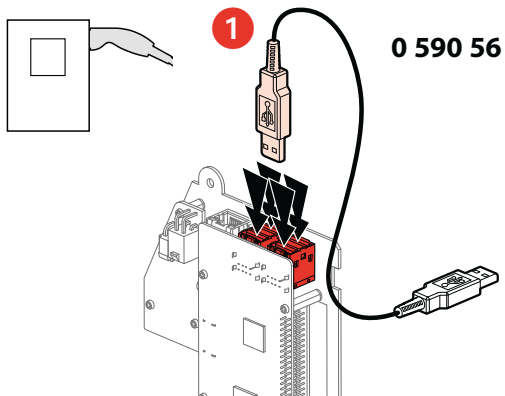
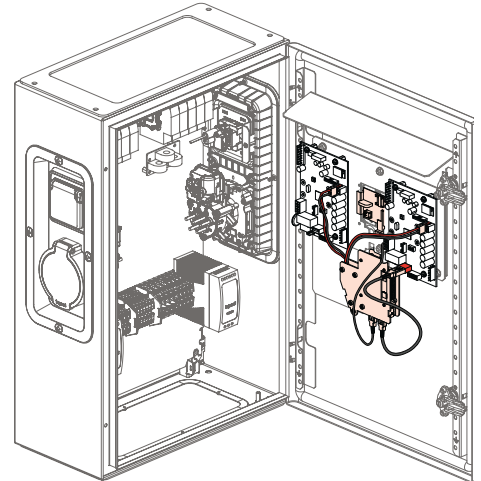

+  
**0 590 56**

+  
**0 590 59** 



**3** **0 590 56 + 0 590 59** 

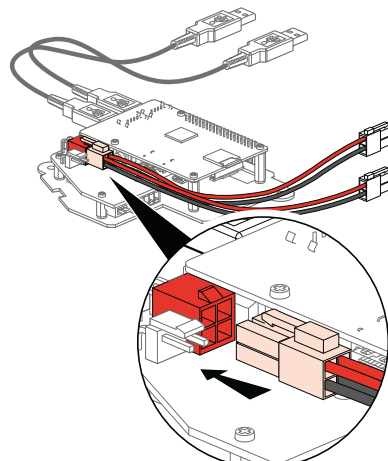



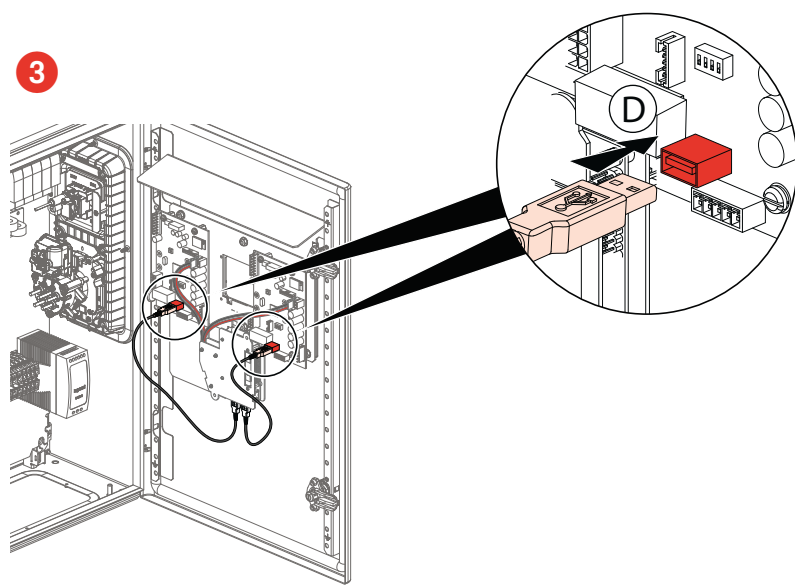
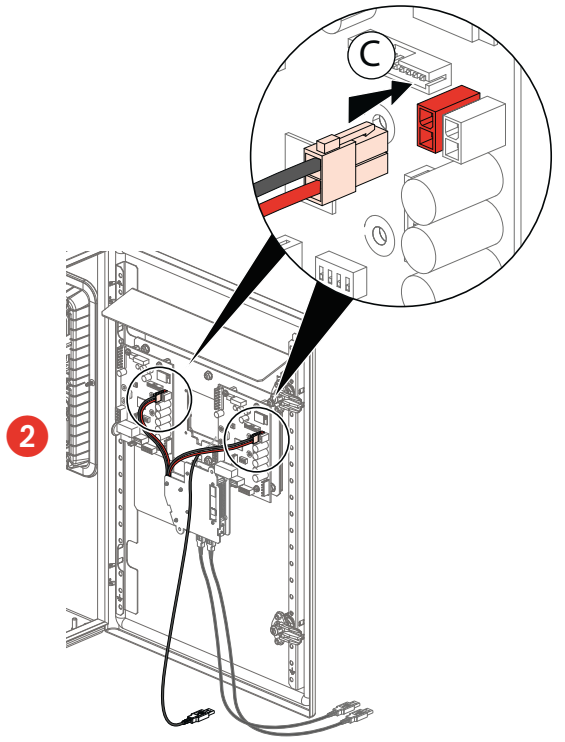
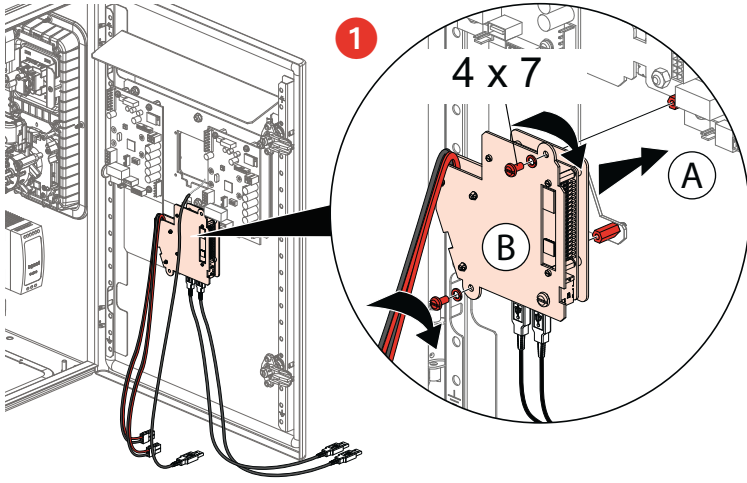

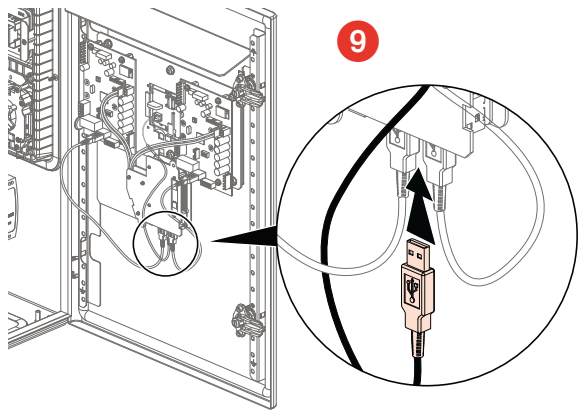
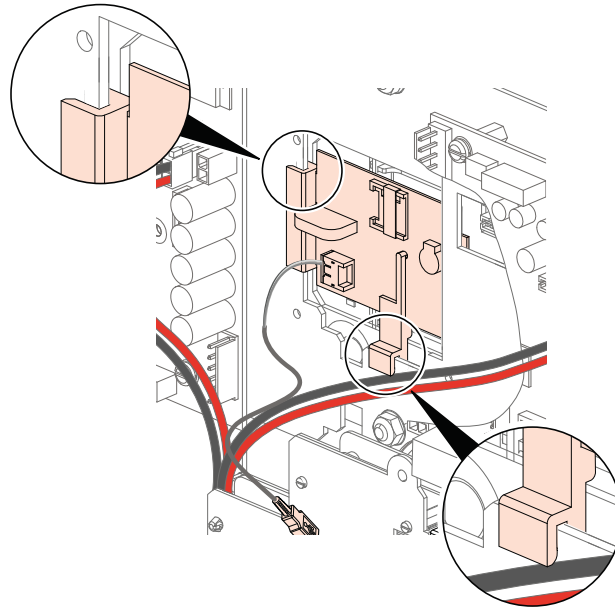
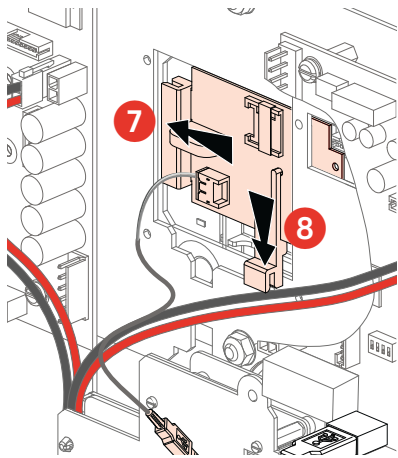
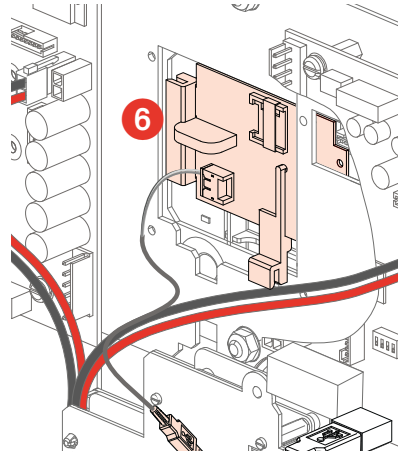
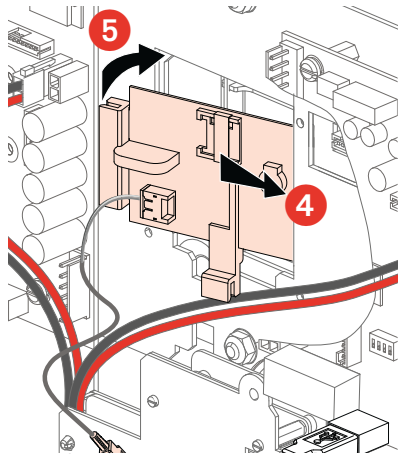

Le soussigné, LEGRAND, déclare que l'équipement radioélectrique du type (0 590 56/59) est conforme à la directive 2014/53/UE. Le texte complet de la déclaration UE de conformité est disponible à l'adresse suivante : [www.legrand.com](http://www.legrand.com)

The undersigned, LEGRAND, declares that radio equipment of type (0 590 56/59) complies with the Directive 2014/53/EU. The full text of the EU declaration of conformity can be found at: [www.legrand.com](http://www.legrand.com)

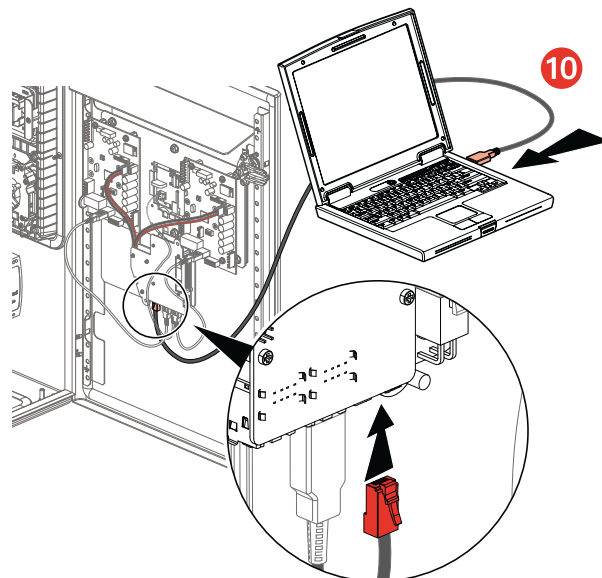



11

12

Après raccordement du kit de communication, une mise à jour de votre borne de charge va s'effectuer. A la mise sous tension, merci de patienter environ 3 minutes avant toute manipulation/configuration. Chaque côté de votre borne de charge effectuera automatiquement 2 re-démarrage pendant ce processus.

*Once the communication kit has been connected, your charging station will update itself.*

*On powering up, please wait at least 3 minutes before any configuration or other work.*

*During this time, each side of your charging station will automatically restart twice.*



Initialisation de la borne  
*Initialising the charging station*

Voyant défilement blanc puis voyant blanc fixe

Attendre le redémarrage de la borne puis

*White scrolling indicator and then steady white indicator*

*Wait for the charging station to restart, and then*



Voyant blanc fixe OK  
*Steady white indicator OK*

13

Configuration, voir page 16

*Configuration, see page 16*

14

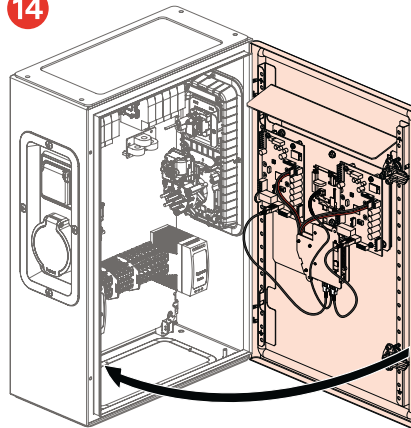

15

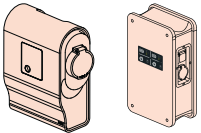
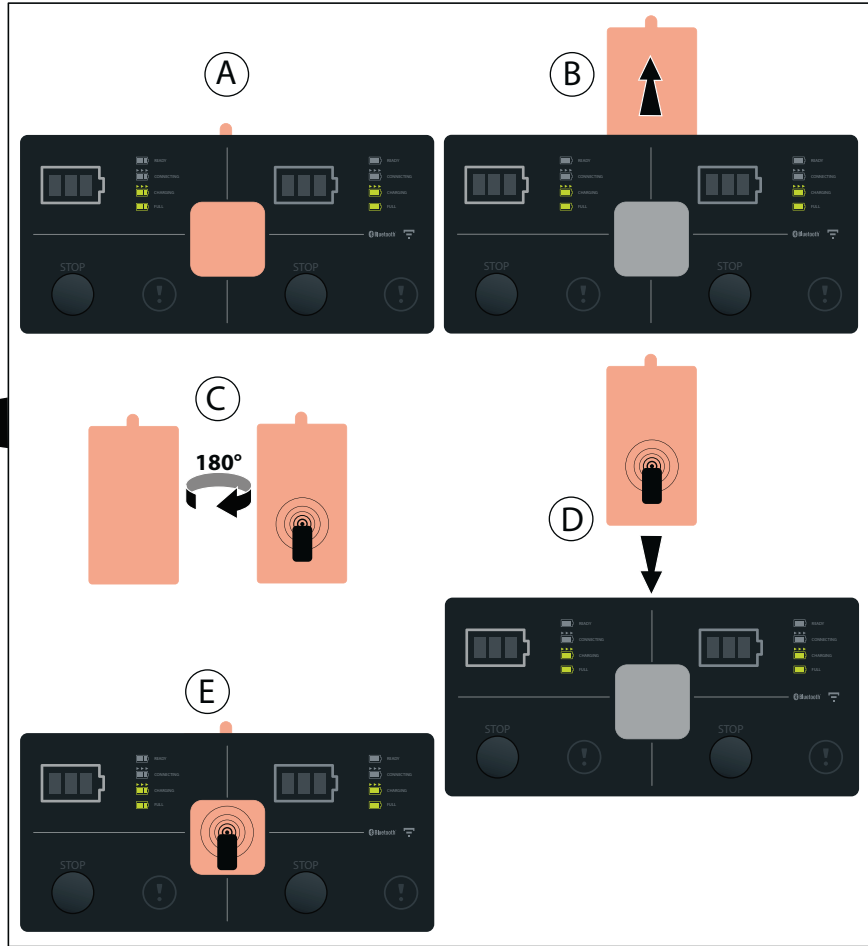
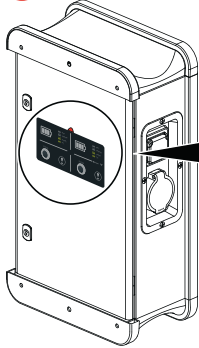

**RACCORDEMENT/CONNECTION 0 590 56/59**

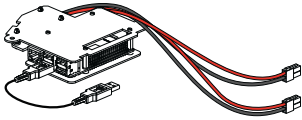
Réfs. / Cat. No.	Gestion - Pages - Web Management - Pages - Web	Application EV charge EV charging app	Modbus	OCPP
<p><b>0 590 56</b></p> 	<p><b>RJ 45</b> <b>ou/or</b> <b>WIFI</b></p>	<p><b>RJ 45</b> <b>ou/or</b> <b>WIFI</b></p>	<p><b>RS 485</b></p>	<p><b>RJ 45</b></p>

## SCHEMA DE RACCORDEMENT RJ 45/RJ 45 CONNECTION DIAGRAM

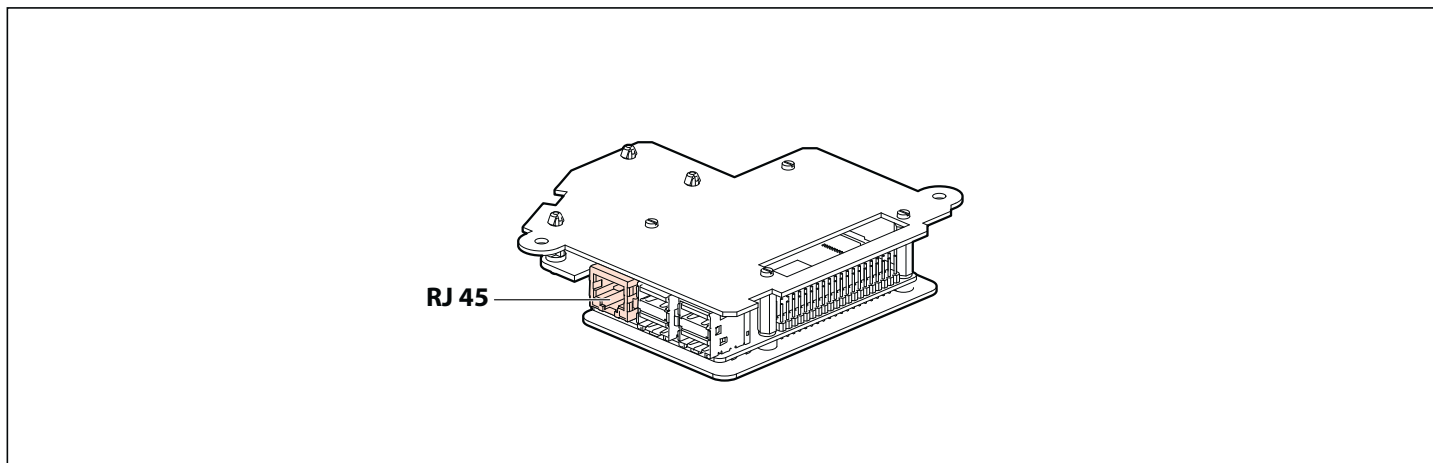

## SCHEMA DE RACCORDEMENT RS485/RS485 CONNECTION DIAGRAM

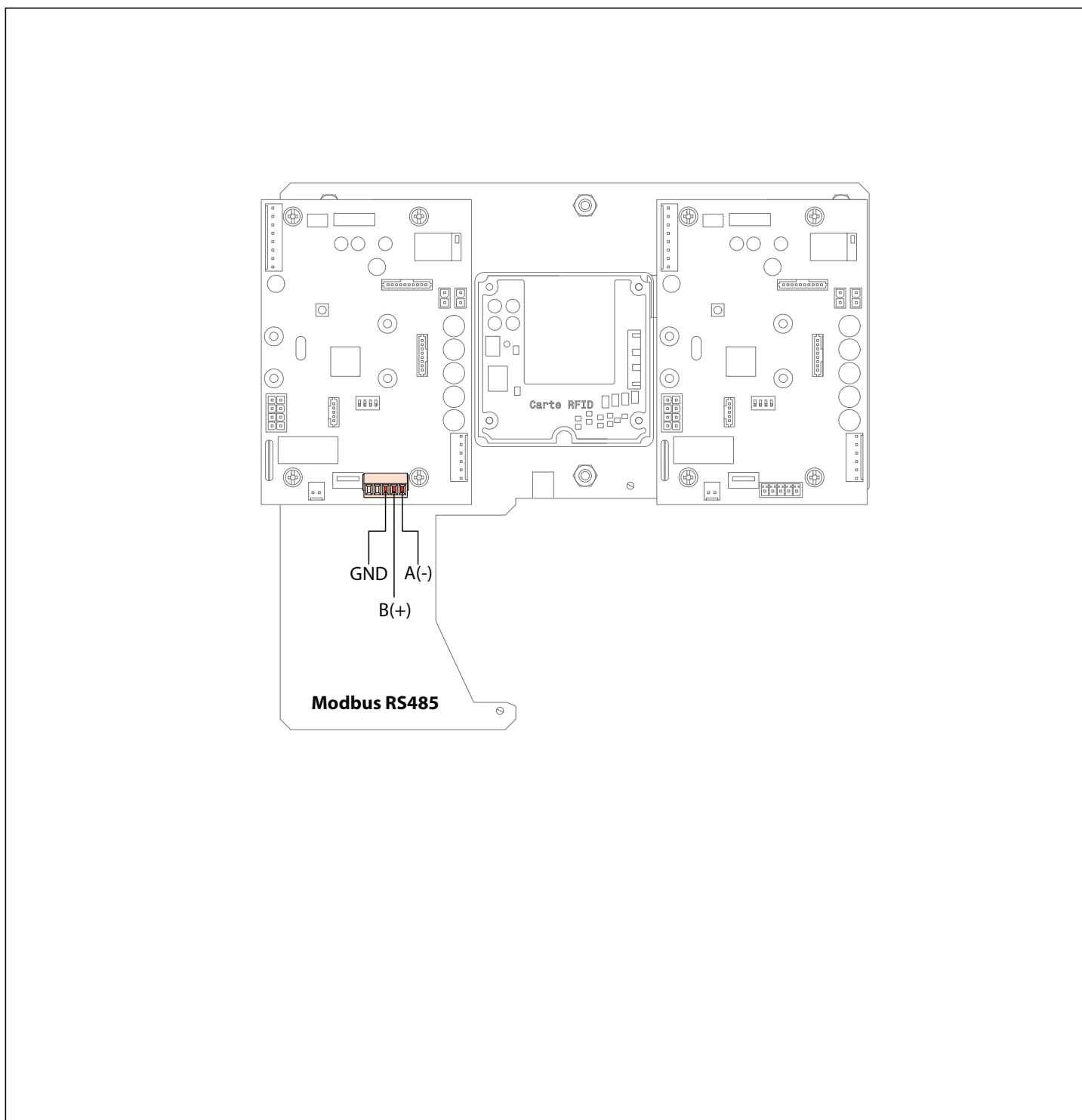

## CONFIGURATION ACCES PAGES WEB

Pour configuration IP, Modbus, RFID

- 1) Connecter le PC en LAN au kit Com via le cordon RJ 45
- 2) Paramétrer un réseau local
  - a) Au centre réseau et partage ((cliquer sur le bouton démarrer (logo voir notice LE08734AA-00) taper «centre réseau et partage» dans la barre de recherche.))
  - b) Cliquer sur connexion au réseau local
  - c) Cliquer sur propriétés
  - d) Cliquer sur protocole internet version 4 (TCP/IP v4)
  - e) Cliquer sur propriétés
  - f) Cliquer sur utiliser l'adresse IP suivante :
    - adresse IP 192.168.1.199**
    - masque de sous réseau 255.255.255.0**
    - passerelle par défaut 192.168.1.1**renseigner les valeurs pour adresse, masque et passerelle
  - g) Cliquer sur OK
  - h) Ouvrir le navigateur et taper l'adresse **IP 192.168.1.200**

3) Ecran formulaire de connexion

- a) Première connexion (login et mot de passe par défaut)

**Login : admin**

**Mot de passe : admin**

- 4) Pour des raisons de sécurité, veuillez changer votre mot de passe

Login :

Mot de passe :

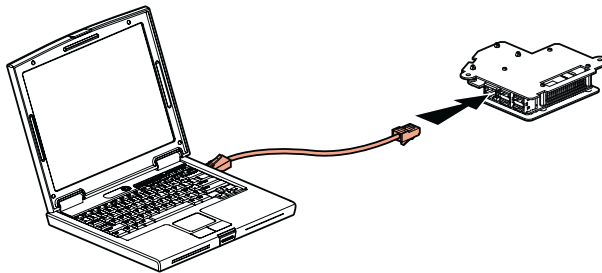

## CONFIGURING ACCESS TO WEB PAGES

For IP, Modbus, RFID configuration

- 1) Connect the PC in LAN configuration to the Com kit via the RJ 45 cable
- 2) Configure a local network
  - a) In the network and sharing centre ((click the Start button (logo in manual LE08734AA-00) and type "network and sharing centre" in the search bar.))
  - b) Click 'Local Area Connection'
  - c) Click 'Properties'
  - d) Click 'Internet protocol version 4 (TCP/IP v4)'
  - e) Click 'Properties'
  - f) Click 'Use the following IP address':
    - IP address 192.168.1.199**
    - Sub-network mask 255.255.255.0**
    - Default gateway 192.168.1.1**Enter the values for address, mask, and gateway
  - g) Click 'OK'
  - h) Open the browser and type the address **IP 192.168.1.200**

3) Login screen

- a) Initial login (default user ID and password)

**User ID: admin**

**Password: admin**

- 4) For security reasons, please change your password

User ID:

Password:

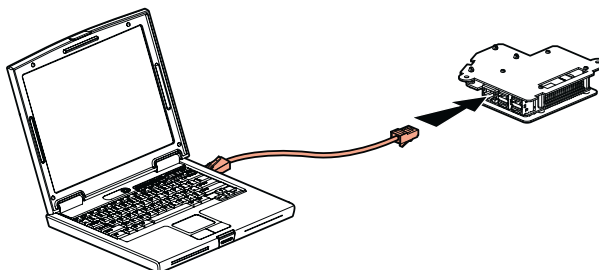

## Ecran d'accueil



## Home screen



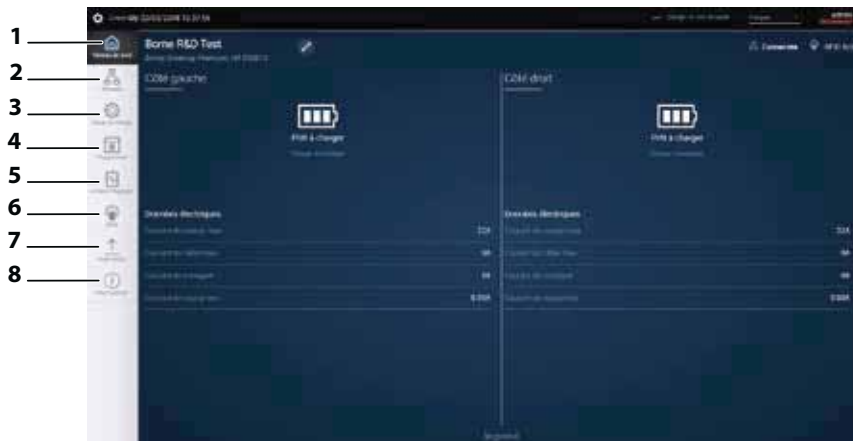

**LEGENDE :**

**1- Tableau de bord**

Permet de visualiser l'état de fonctionnement de la borne par coté

**2- Réseau**

Permet de configurer un réseau filaire et/ou sans fil (Wifi)

**3- Mode de charge**

Permet de choisir le mode de charge de la borne par coté

**4- Programmes**

Permet de gérer la programmation horaire de la borne par coté

**5- Actions réglages**

Permet d'effectuer des actions à distance de la borne (intensité, verrouillage, arrêt de charge ....)

**6- RFID**

Permet :

- l'activation du RFID (avec réf. 0 590 59)
- la gestion des badges
- la gestion du mode de fonctionnement local ou à distance

**7- Historique**

Permet de télécharger les historiques de charge et d'erreurs de la borne par coté

**8- Informations/Mises à jour**

Permet la visualisation des informations système de la borne (version software et hardware)



**Avant toute première mise en service, téléchargez le manuel d'utilisation et installez la dernière mise à jour de votre kit de communication sur [www.legrand.com](http://www.legrand.com)**

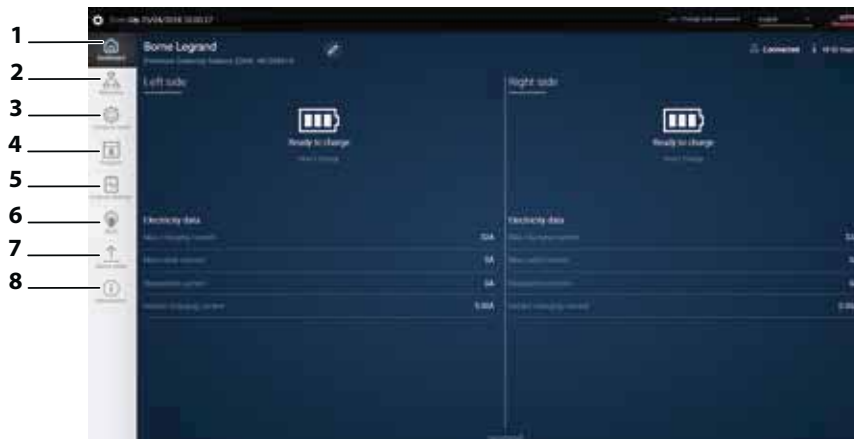

**KEY:**

**1- Dashboard**

Lets you view the operating status of each side of the charging station

**2- Network**

Lets you configure a wired and/or wireless network (WiFi)

**3- Charging mode**

Lets you choose the charging mode of each side of the charging station

**4- Programs**

Lets you manage the timer programming for each side of the charging station

**5- Settings actions**

Lets you apply actions to the charging station remotely (brightness, locking, stop charging, etc)

**6- RFID**

Lets you:

- enable the RFID (with Cat. No. 0 590 59)
- manage keycards
- manage the operating mode: local or remote

**7- History**

Lets you download the charging station charging and error logs for each side

**8- Information/Updates**

Lets you view the charging station system information (software version and hardware)



**Prior to any commissioning, download the user manual and install the latest update of your communication kit from [www.legrand.com](http://www.legrand.com)**



# 1. Enregistrement local des badges sur la borne :

Se connecter au kit de communication :

Ouvrir l'onglet RFID

Activer le lecteur RFID

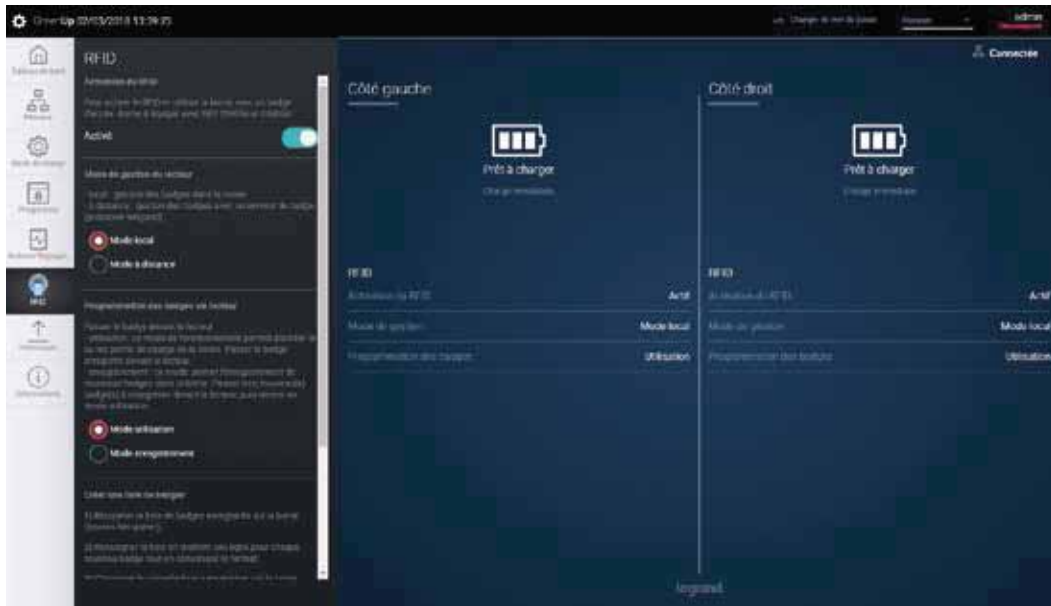

Sélectionner « Mode Local»

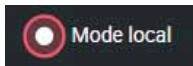

# 1. Local registration of keycards on the terminal:

Connect to the communication kit:

Open the RFID tab

Enable the RFID reader

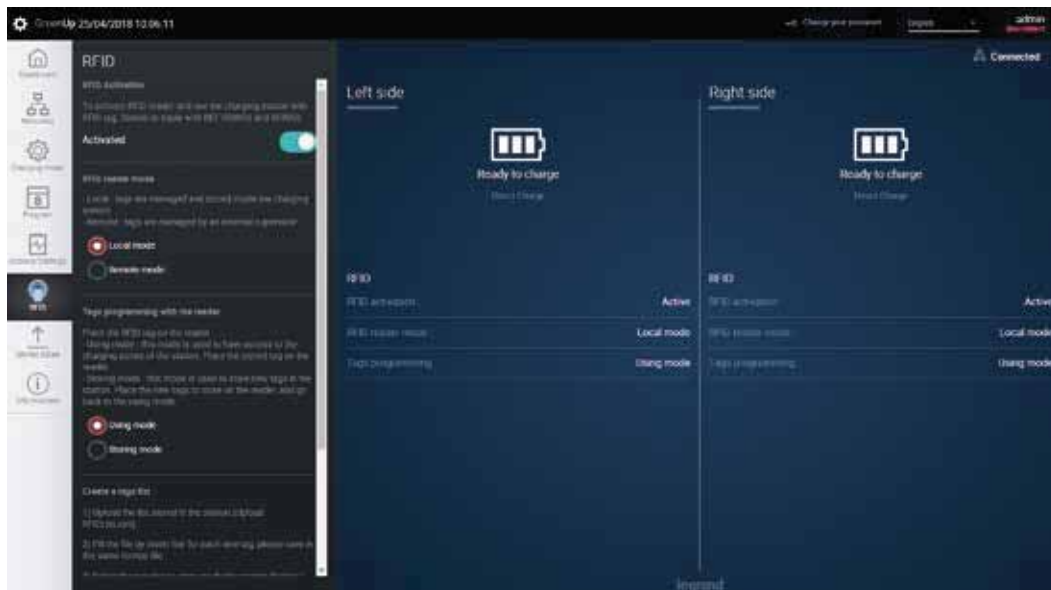

Select "Local Mode"

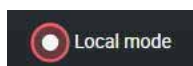

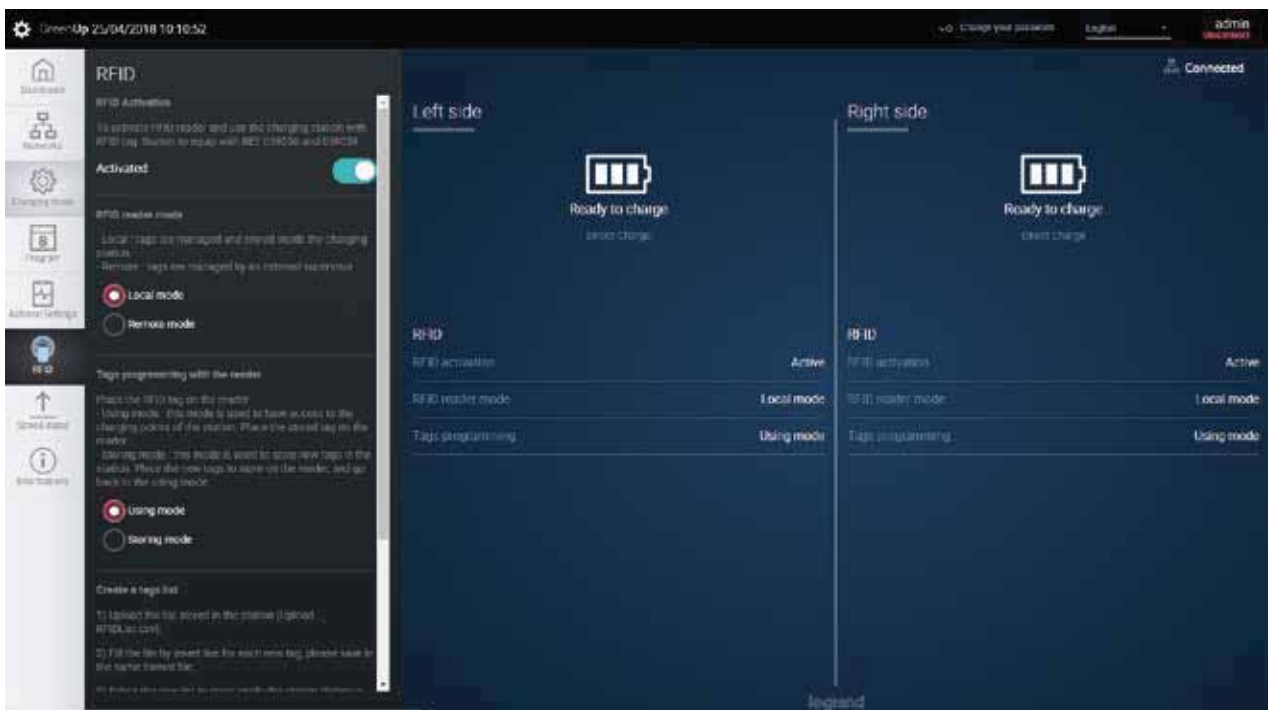

Sélectionner «Mode Enregistrement»

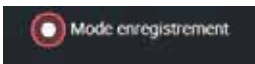

Select "Remote Mode"

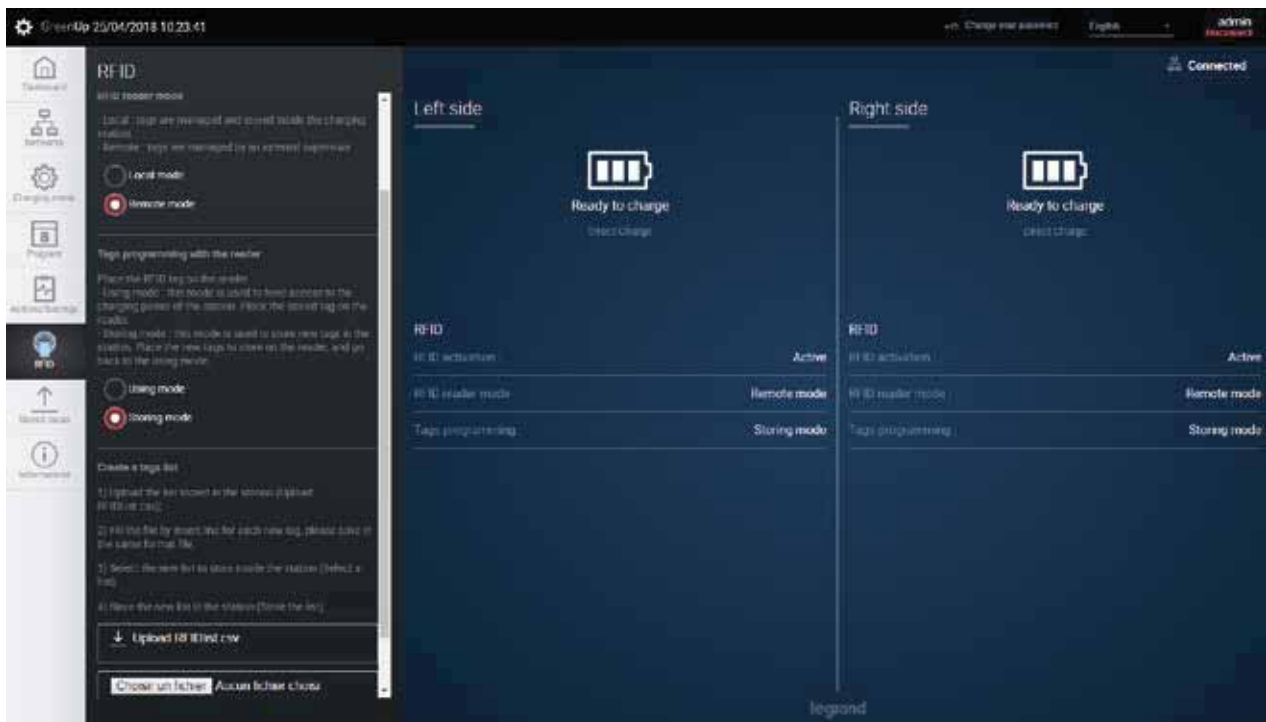
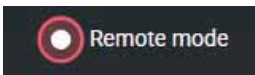

Ensuite, se rendre devant la borne : Défilement blanc des voyants sur l'interface  
 ⇒ La borne est prête à enregistrer les badges  
 Passer le badge à enregistrer devant le lecteur RFID : défilement vert des voyants  
 ⇒ Le badge est enregistré  
 Renouveler l'opération autant de fois que de badges à enregistrer  
 A l'issue de l'enregistrement des badges, revenir au mode utilisation



**Remarque :** Si on passe devant la borne un badge déjà enregistré, un clignotement rouge a lieu

Next, stand in front of the charging station: White scrolling of indicator lights on the interface  
 ⇒ The charging station is ready to register the keycards  
 Swipe the keycard to be registered in front of the RFID reader: green scrolling indicator lights  
 ⇒ The keycard is registered  
 Repeat the operation for each keycard to be registered  
 On completion of keycard registration, return to operating mode

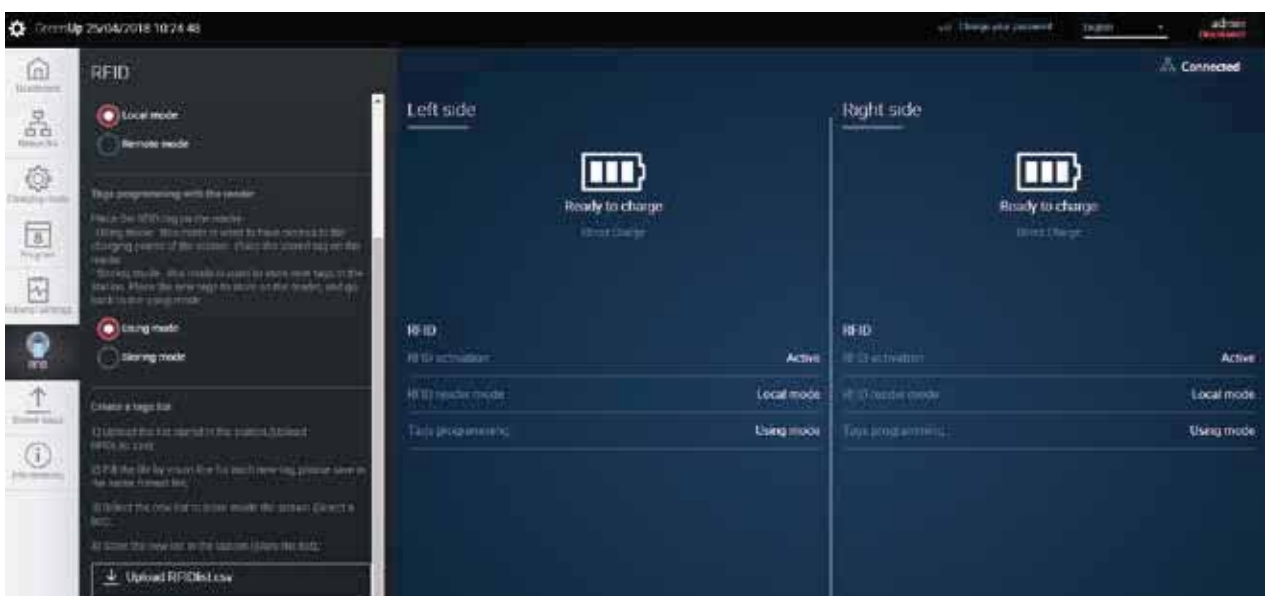

**Note:** If a keycard that is already registered is swiped in front of the terminal, a red indicator flashes

## 2. Création et utilisation d'une liste de badges

Se connecter au kit de communication :  
Ouvrir l'onglet RFID  
Activer le lecteur RFID



Sélectionner «Mode Local»

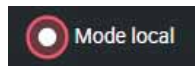

Sélectionner «Mode enregistrement»

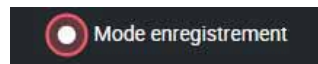

## 2. Creating and using a keycard list

Connect to the communication kit:  
Open the RFID tab  
Enable the RFID reader

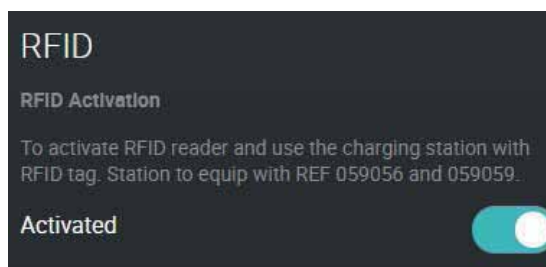

Select "Local mode"

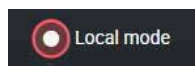

Select "Storing mode"

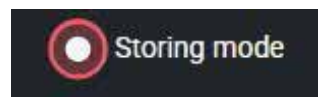

Exemple de liste de badges :

Respecter absolument le format ci-dessous

(dates et noms facultatifs) :

Date	Id	Name
26/02/2018 08:40	2000236672	Dupont
26/02/2018 08:39	2000243520	Durand
26/02/2018 08:39	1997833664	Martin

End

a) Création d'une liste de badges :

- créer un fichier RFIDList.csv suivant les conditions ci-dessus
- compléter avec les données de badges et éventuellement de noms et dates correspondants
- Cliquer sur «+ ajouter une liste de badge» pour le sélectionner

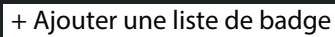
 Aucun fichier choisi

- Cliquer sur «enregistrer RFIDList.csv»

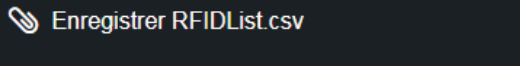

⇒ Votre liste de badge est enregistrée

b) Edition d'une liste de badges :

- Cliquer sur «récupérer RFIDList.csv»

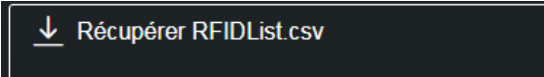

c) Modification d'une liste de badges

- Cliquer sur «enregistrer RFIDList.csv»

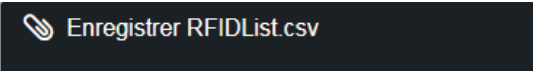

- Effectuer vos modifications dans le fichier (ajouts, suppressions, changement d'utilisateur)

- Enregistrer vos modifications

- Cliquer sur «choisir un fichier» pour le sélectionner

- Cliquez sur «enregistrer RFIDList.csv»

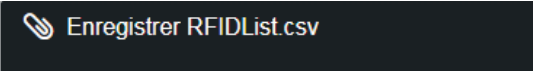

⇒ Votre nouvelle liste de badge est enregistrée

*Example of keycard list:*

*Strictly adhere to the following format  
(dates and names are optional):*

Date	Id	Name
26/02/2018 08:40	2000236672	Dupont
26/02/2018 08:39	2000243520	Durand
26/02/2018 08:39	1997833664	Martin

End

*a) Creating a keycard list:*

- create a file called *RFIDList.csv* according to the above conditions
- enter the keycard data and, where appropriate, the corresponding names and dates
- Click "+ ADD a tag list" to select it



- Click "Upload *RFIDList.csv*"



⇒ Your keycard list has been saved

*b) Editing a keycard list:*

- Click "Upload *RFIDList.csv*"



*c) Modifying a keycard list*

- Click "Store *RFIDList.csv*"

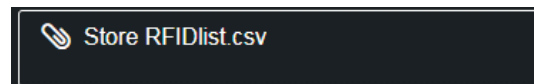

- Make your changes in the file (additions, deletions, change user)

- Save your changes

- Click "Choose file" to select it

- Click "Store *RFIDList.csv*"



⇒ Your new keycard list has been saved



### 3. Utilisation du lecteur de badges avec une gestion centralisée

Se connecter au kit de communication :

Ouvrir l'onglet RFID

Activer le lecteur RFID

Sélectionner «Mode à distance»  
(utilisation du protocole de communication Wiegand)

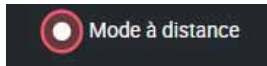

### 3. Using the keycard reader with centralised management

Connect to the communication kit:

Open the RFID tab

Enable the RFID reader

Select "Remote mode"  
(using the Wiegand communication protocol)

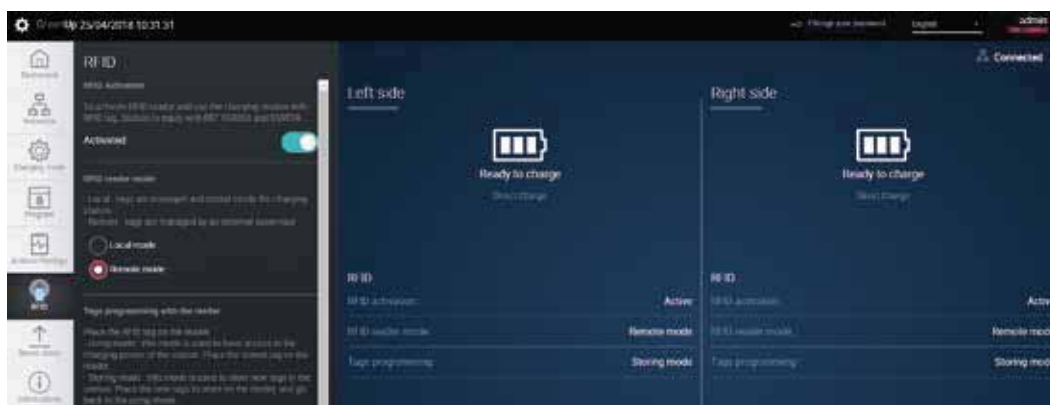
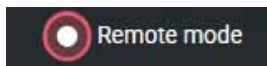



#### 4. Utilisation de la borne avec des badges RFID

Activer le lecteur RFID



Sur l'onglet RFID, passer en mode utilisation

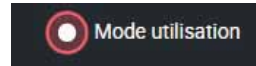

Suivant l'ordre des opérations

- a) Brancher votre cordon sur la borne  
Passer le badge devant la borne  
Les voyants blancs clignotent coté cordon => la charge démarre
- b) Passer votre badge devant la borne :  
les voyants verts clignotent  
Brancher votre cordon (durée maximum :  
1 minute, au-delà d'une minute, repasser le badge devant la borne)

5. La charge démarre

##### **Badge non enregistré :**

Si on passe un badge non enregistré devant la borne :  
clignotement «flash» des voyants rouges

#### 4. Using the terminal with RFID keycards

Enable the RFID reader

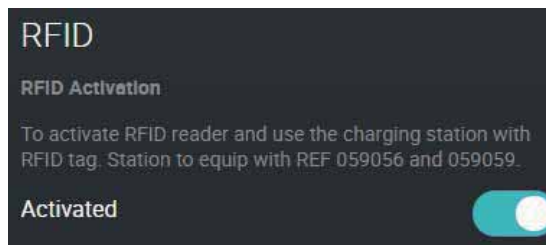

In the RFID tab, switch to using mode

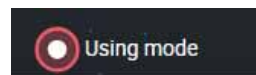

- a) Connect your cable to the terminal  
Swipe the keycard in front of the terminal  
The white indicator lights flash on the cable side => charging starts
- b) Swipe your keycard in front of the terminal:  
the green indicator lights flash  
Connect your cable (maximum duration:  
1 minute; after one minute, swipe the keycard in front of the terminal again)

5. Charging starts

##### **Unregistered keycard:**

If an unregistered keycard is swiped in front of the terminal:  
red indicator lights flash

**A télécharger sur**  
*Downloadable from*  
[www.legrand.com](http://www.legrand.com)  
**LE10817AA-01 (FR)**  
**LE10990AA-01 (EN)**

**BORNES GREEN'UP PREMIUM**  
**GREENUP PREMIUM CHARGING STATIONS**

**Manuel d'utilisation**  
*User manual*

**Kit de communication & lecteur RFID**  
*Communication kit & RFID reader*



 **Consignas de seguridad / Recomendações de segurança**

 **DEEE**



Configuración de acceso páginas WEB ..... p 44  
 Configuração do acesso a páginas Web ..... p 44

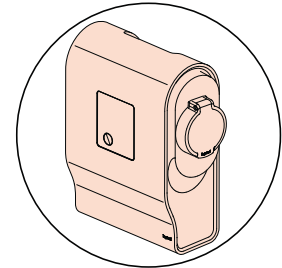

Instalación/Instalação  
 0 590 56 ..... p 30

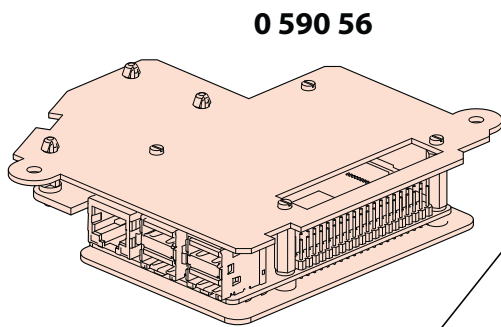

**0 590 56**

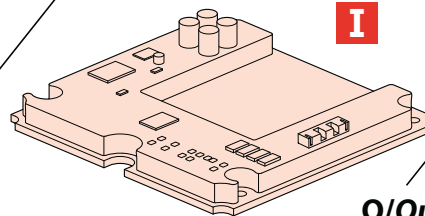

**0 590 59**

**O/Ou**

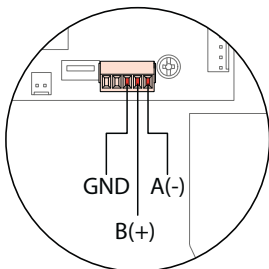
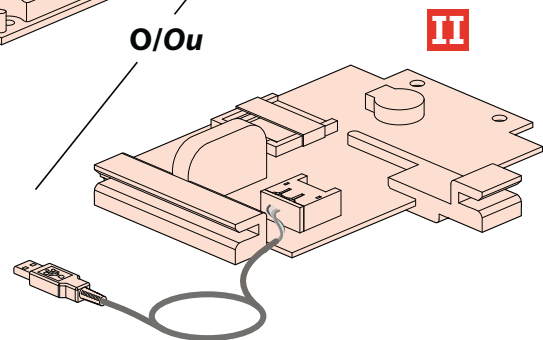

Conexiones ..... p 42  
 Ligação dos conectores ..... p 42

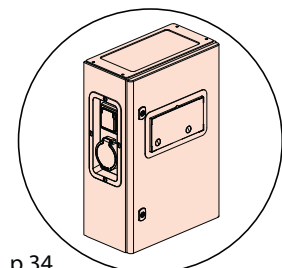

Instalación/Instalação  
 0 590 56 o/ou  
 0 590 56 + 0 590 59 ..... p 34



0 590 56

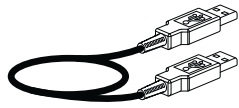
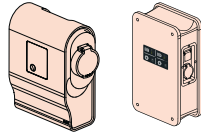

x 2

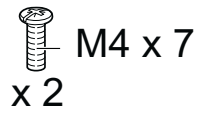
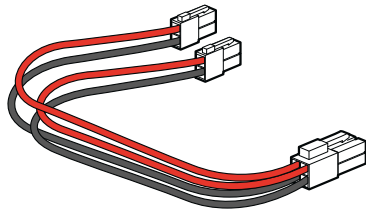
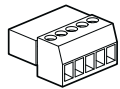
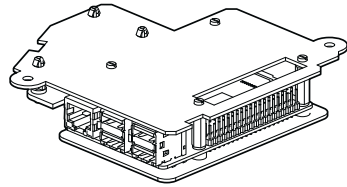

x 2

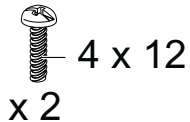

x 2

0 590 59

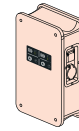

I

O/Ou

II

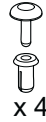

x 4

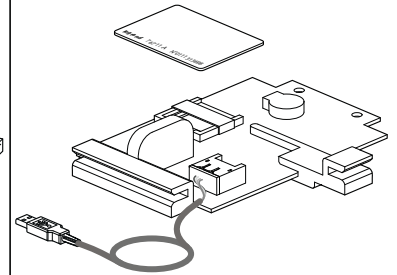
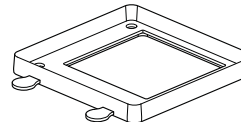
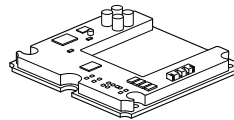
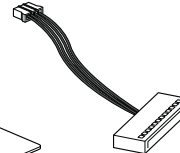

**Antes de realizar cualquier intervención, cortar la corriente.  
Cumplir estrictamente las condiciones de instalación y uso.  
Antes de qualquer intervenção, desligar a corrente.  
Respeitar rigorosamente as condições de instalação e utilização.**

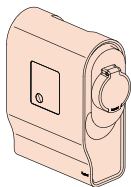

+ 0 590 56

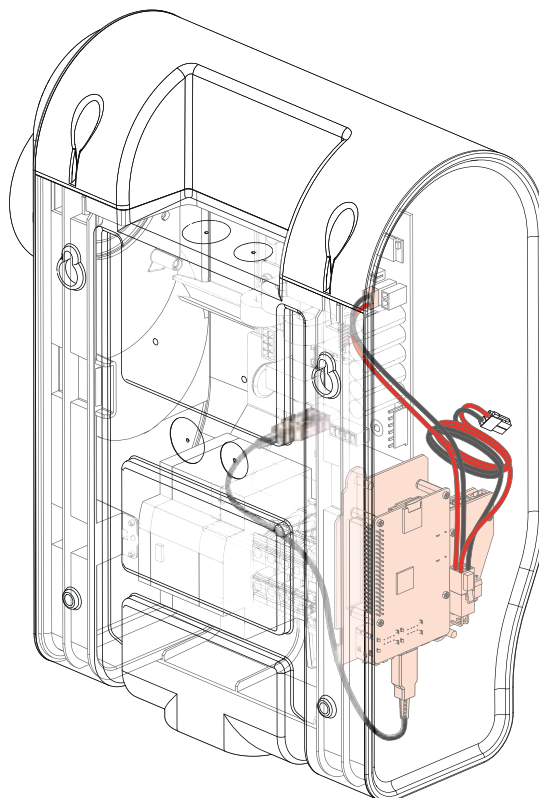

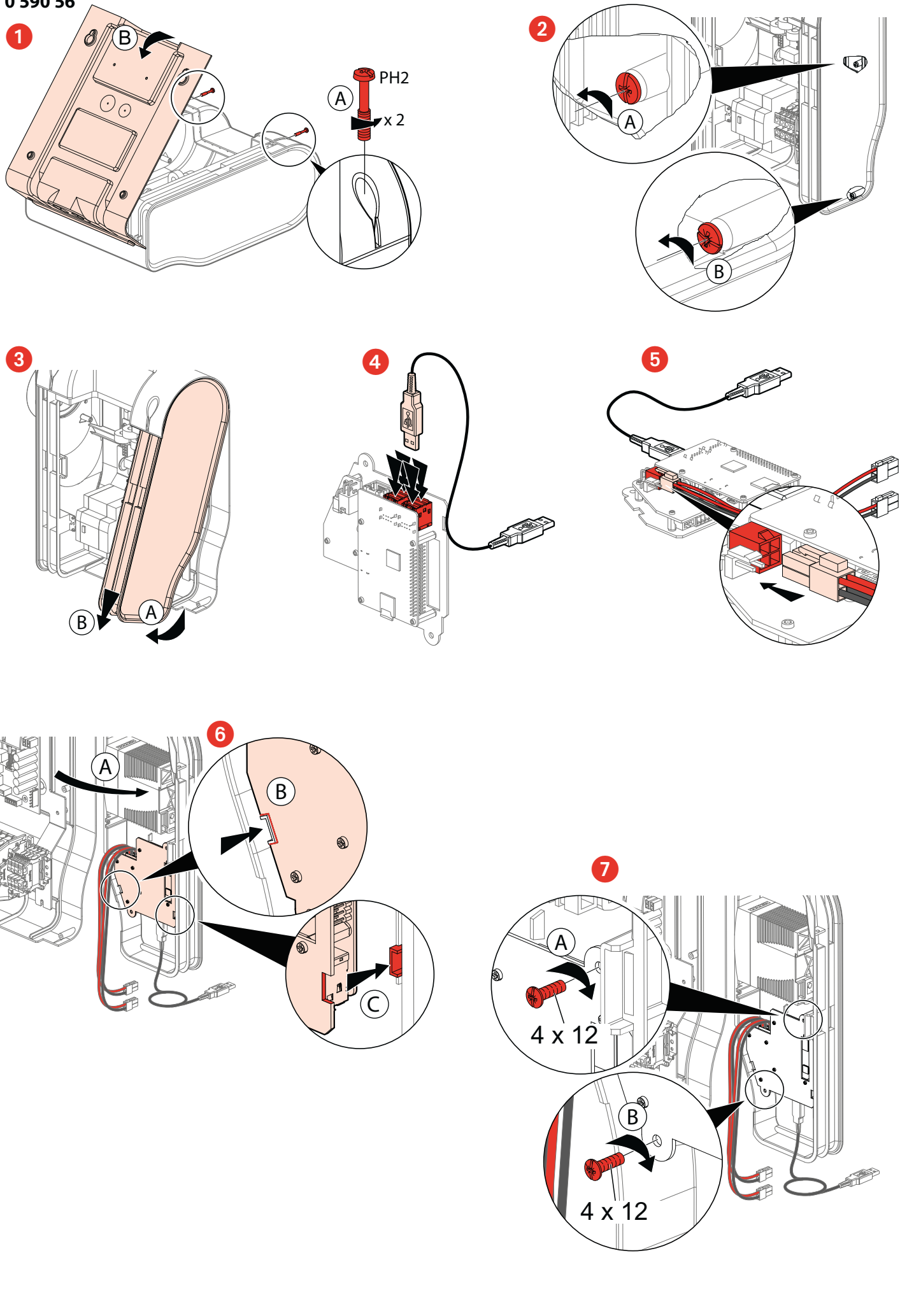

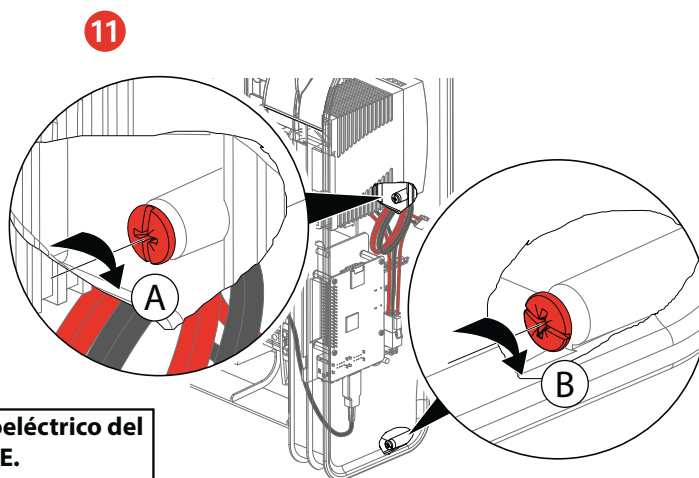
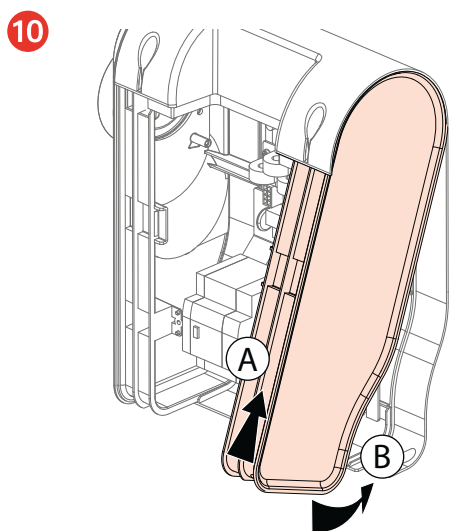
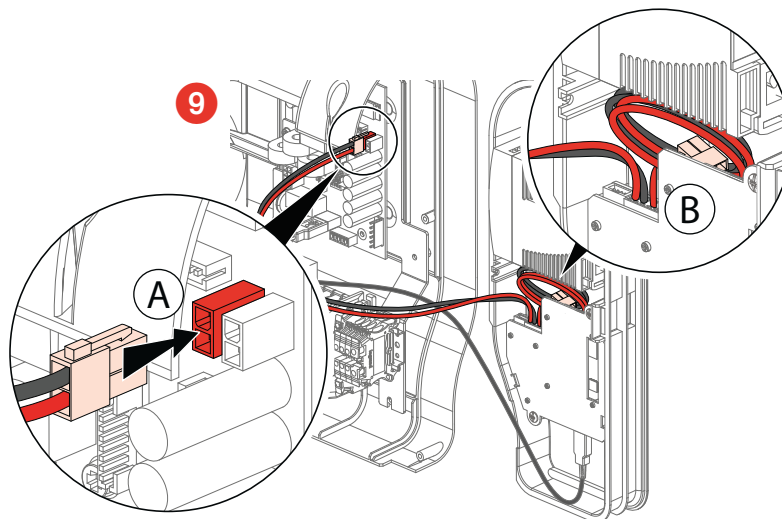
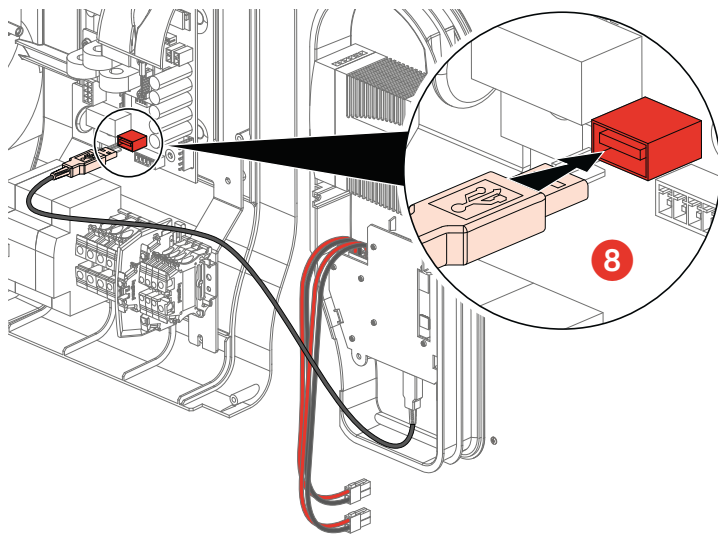

El abajo firmante LEGRAND declara que el equipo radioeléctrico del tipo (0 590 56/59) es conforme a la Directiva 2014/53/UE. El texto completo de la declaración UE de conformidad se encuentra disponible en la siguiente dirección: [www.legrand.com](http://www.legrand.com)

O abaixo assinado, LEGRAND, declara que o equipamento radioelétrico do tipo (0 590 56/59) está em conformidade com a Diretiva 2014/53/UE.

O texto completo da Declaração de Conformidade UE está disponível no seguinte endereço: [www.legrand.com](http://www.legrand.com)



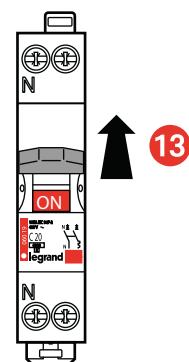
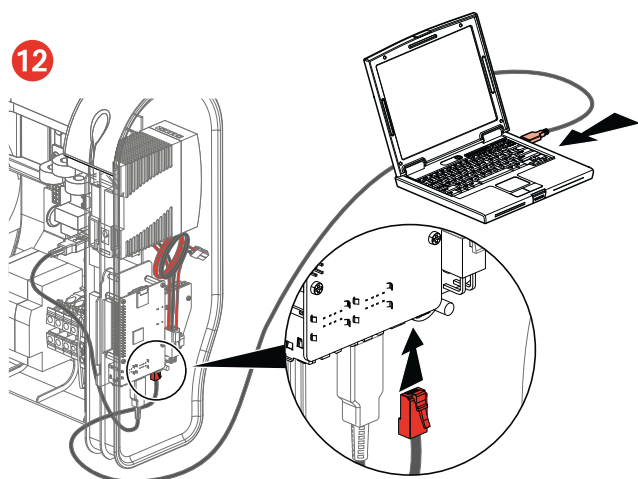

- 14** Tras la conexión del kit de comunicación, se realizará una actualización de su terminal de carga. En el momento del encendido espere aproximadamente 3 minutos antes de manipularlo/configurarlo. Cada lado de su terminal de carga realizará automáticamente 2 reinicios durante ese proceso.  
*Após a ligação do kit de comunicação, será efetuada uma atualização do terminal de carga. Após a colocação sob tensão, aguardar aproximadamente 3 minutos antes de iniciar qualquer manipulação/configuração. Cada lado do terminal de carga realizará automaticamente 2 reinícios durante este processo.*



Inicio del terminal  
*Inicialização do terminal*

Piloto móvil blanco a continuación piloto blanco fijo  
*Indicador luminoso a branco gradual e em seguida branco contínuo*  
 Esperar el reinicio del terminal, a continuación  
*Aguarde o reinício do terminal e em seguida*

**Nota: para configuración, consultar página 44**  
**Nota: para a configuração, consulte a página 44**



Piloto blanco fijo OK  
*Indicador luminoso a branco contínuo OK*

- 15** Entradas de cables para conexión alámbrica (RJ45), ver página 3 de las instrucciones de su borna de carga n.º LE09745AA  
*Entradas de cabos para a ligação com fios (RJ45), ver página 3 do manual de instruções do seu posto de recarregamento n.º LE09745AA*

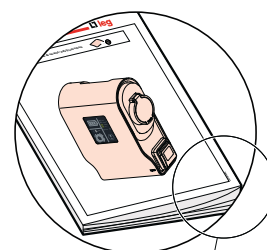

**LE09745AA**

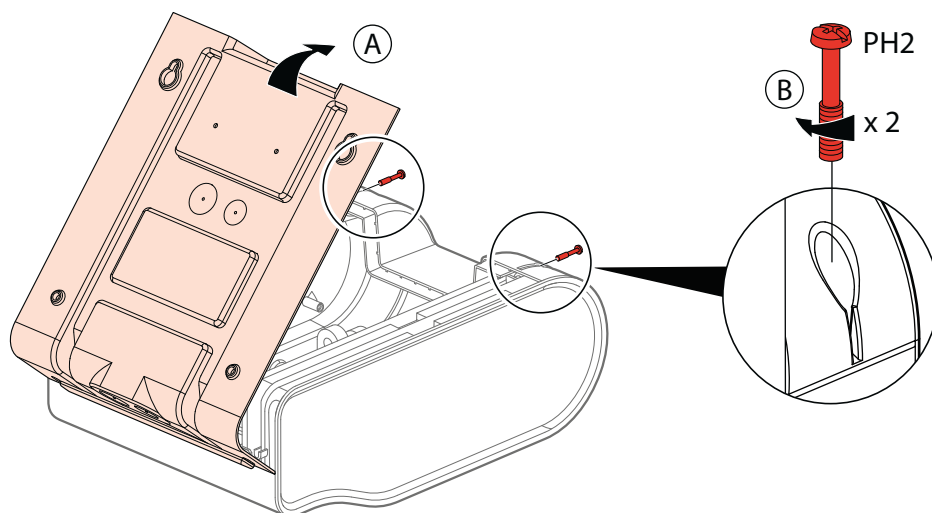



Antes de realizar cualquier intervención, cortar la corriente.  
Cumplir estrictamente las condiciones de instalación y uso.  
Antes de qualquer intervenção, desligar a corrente.  
Respeitar rigorosamente as condições de instalação e utilização.

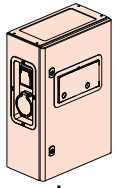

+  
0 590 56

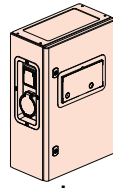
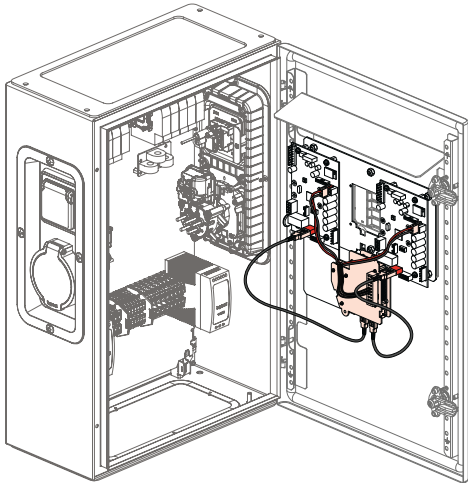

+  
0 590 56  
+  
0 590 59 **I**

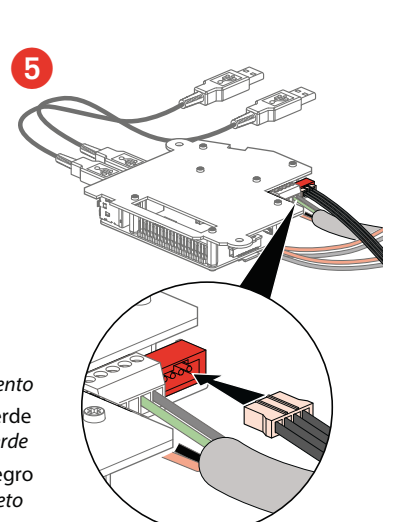
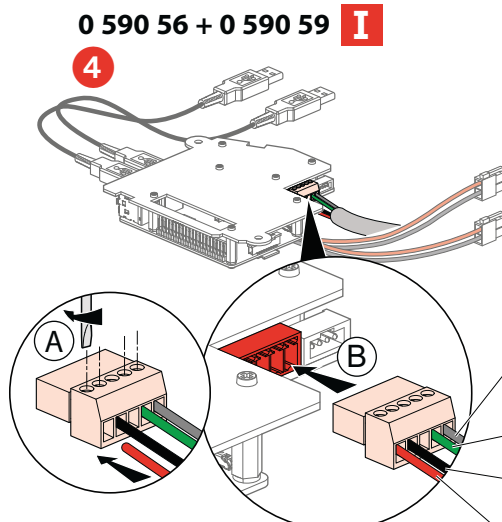
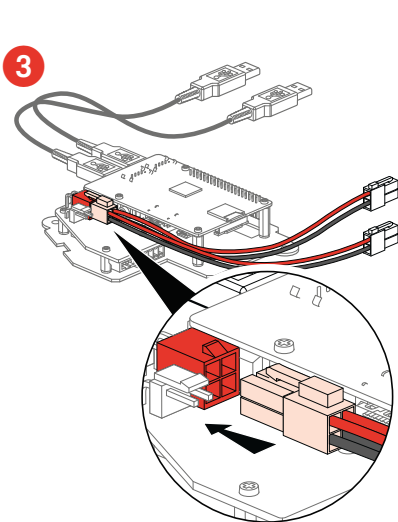
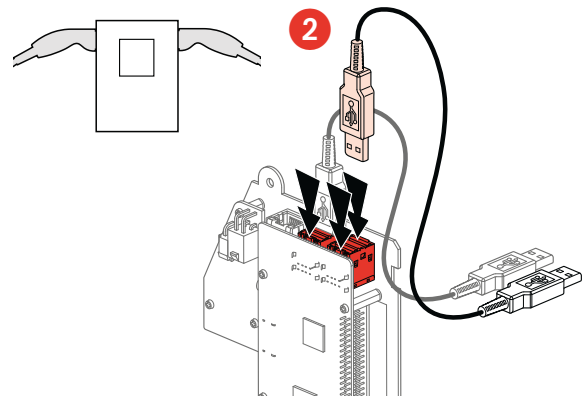
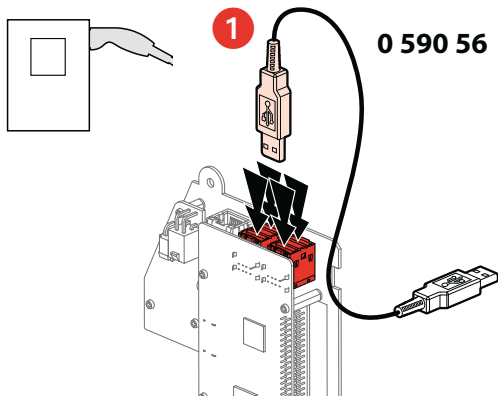
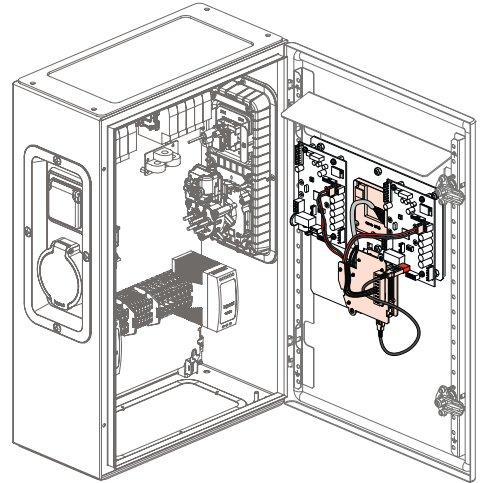

Gris  
Cinzento  
Verde  
Verde  
Negro  
Preto  
Rojo  
Vermelho



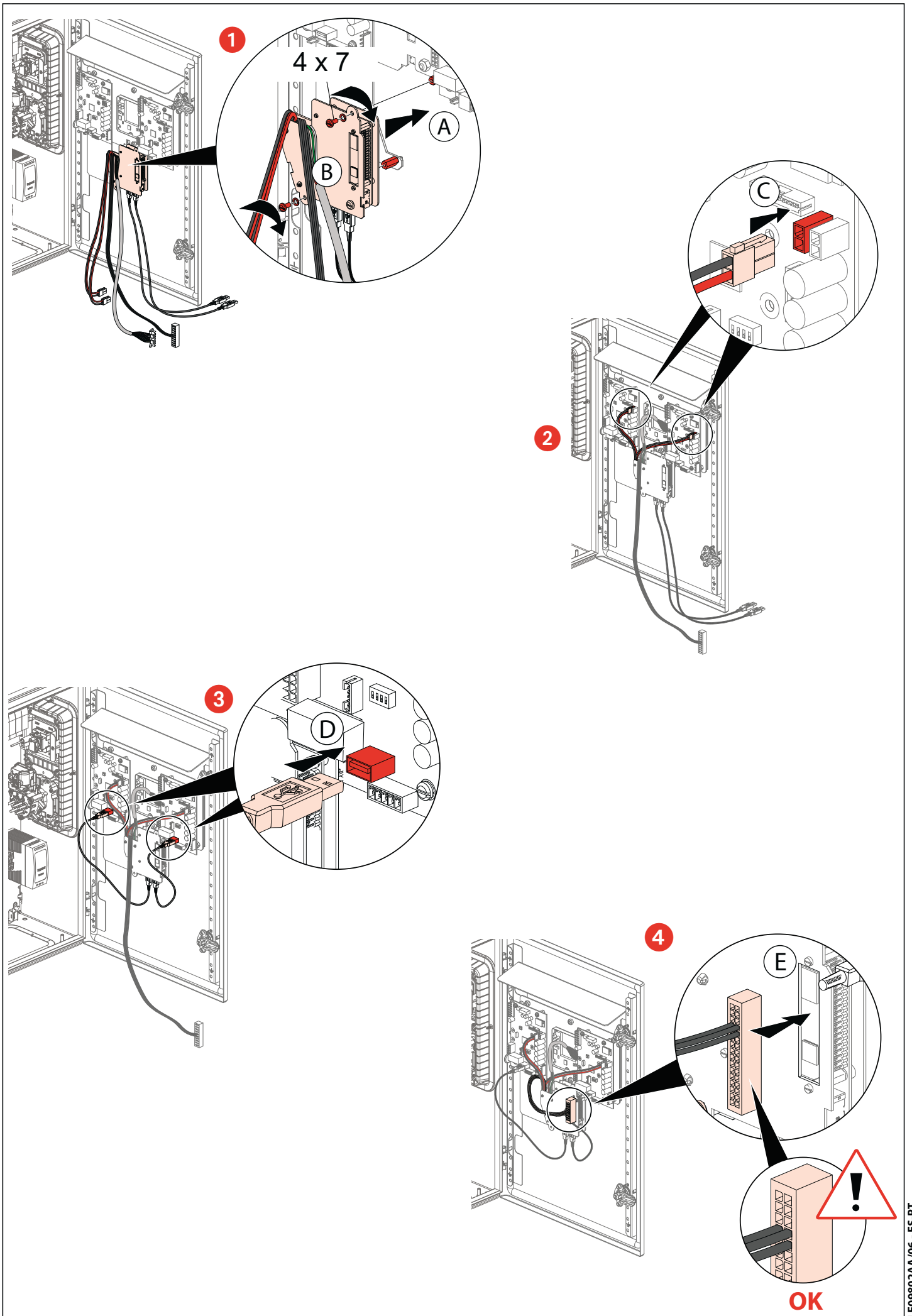

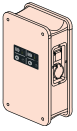

+ 0 590 59 **I**

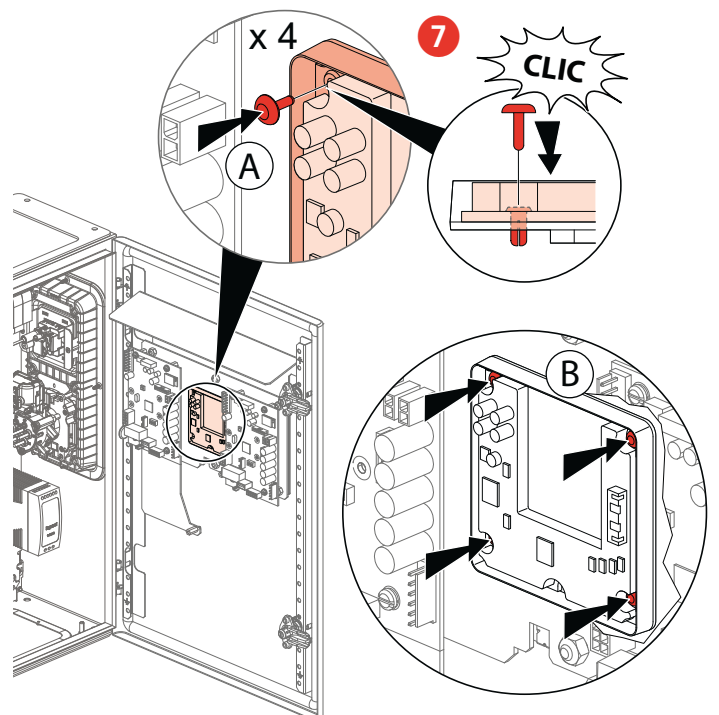
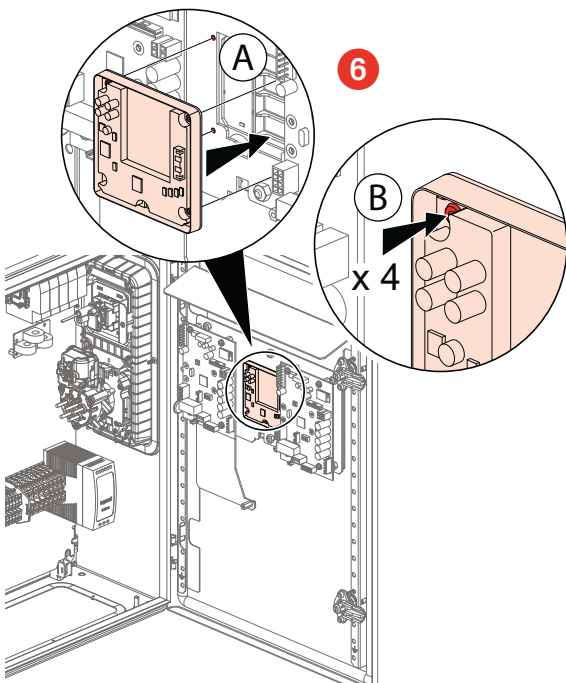
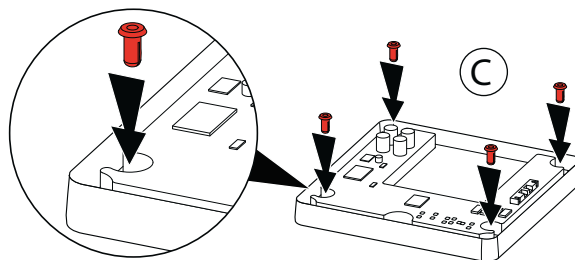
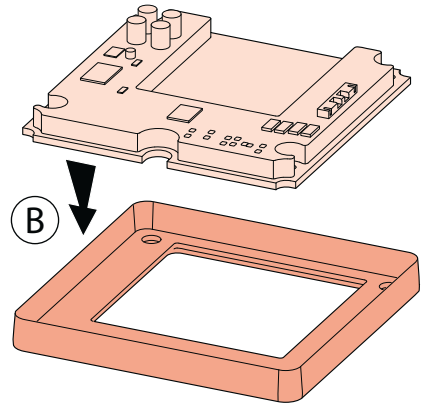
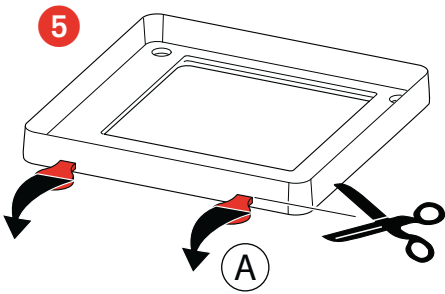

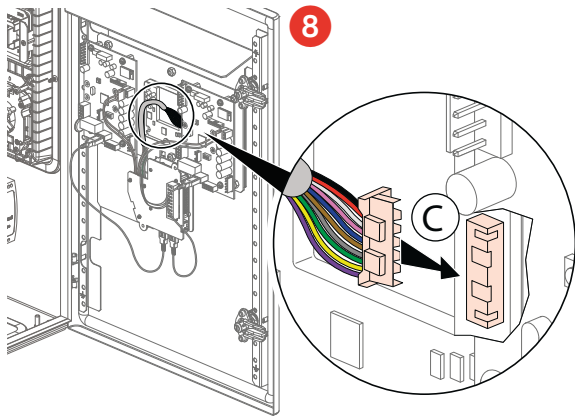

El abajo firmante LEGRAND declara que el equipo radioeléctrico del tipo (0 590 56/59) es conforme a la Directiva 2014/53/UE.  
 El texto completo de la declaración UE de conformidad se encuentra disponible en la siguiente dirección: [www.legrand.com](http://www.legrand.com)

O abaixo assinado, LEGRAND, declara que o equipamento radioelétrico do tipo (0 590 56/59) está em conformidade com a Diretiva 2014/53/UE.  
 O texto completo da Declaração de Conformidade UE está disponível no seguinte endereço: [www.legrand.com](http://www.legrand.com)

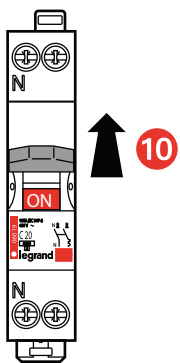
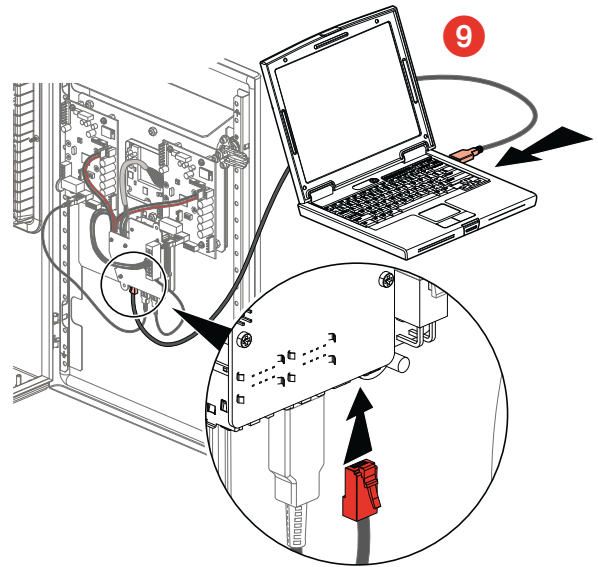

**11**  
 Tras la conexión del kit de comunicación, se realizará una actualización de su terminal de carga. En el momento del encendido espere aproximadamente 3 minutos antes de manipularlo/configurarlo.  
 Cada lado de su terminal de carga realizará automáticamente 2 reinicios durante ese proceso.  
 Após a ligação do kit de comunicação, será efetuada uma atualização do terminal de carga.  
 Após a colocação sob tensão, aguardar aproximadamente 3 minutos antes de iniciar qualquer manipulação/configuração.  
 Cada lado do terminal de carga realizará automaticamente 2 reinícios durante este processo.



Inicio del terminal  
 Inicialização do terminal

Piloto móvil blanco a continuación piloto blanco fijo  
 Esperar el reinicio del terminal, a continuación  
 Indicador luminoso a blanco gradual e em seguida branco contínuo  
 Aguarde o reinício do terminal e em seguida



Piloto blanco fijo OK  
 Indicador luminoso a blanco contínuo OK

**12**  
 Configuración, ver página 44  
 Configuração, ver página 44

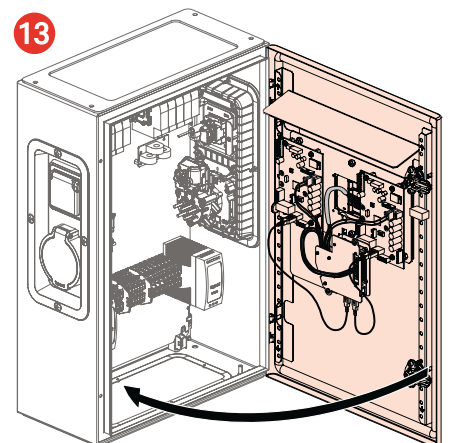



Antes de realizar cualquier intervención, cortar la corriente.  
Cumplir estrictamente las condiciones de instalación y uso.  
Antes de qualquer intervenção, desligar a corrente.  
Respeitar rigorosamente as condições de instalação e utilização.

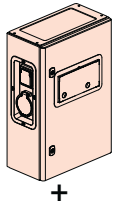

+  
0 590 56

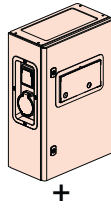
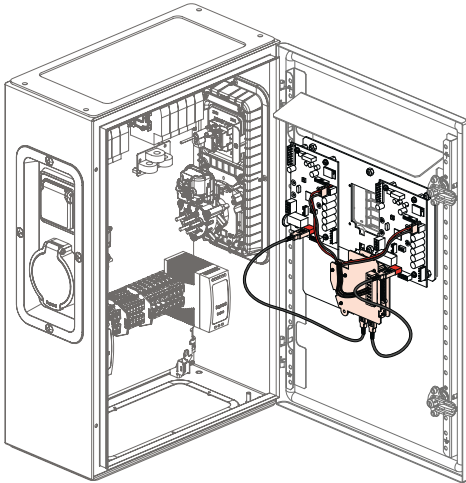

+  
0 590 56  
+  
0 590 59 **II**

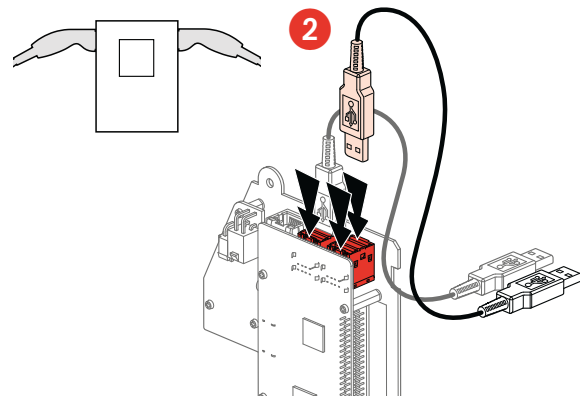
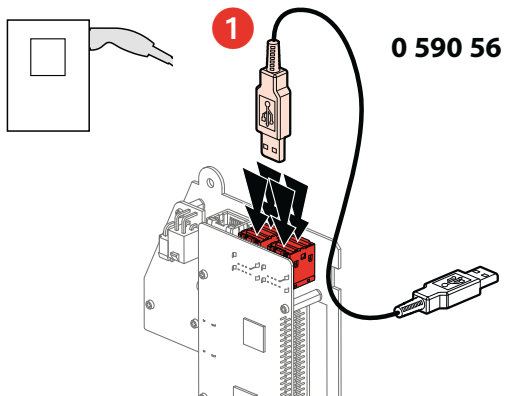
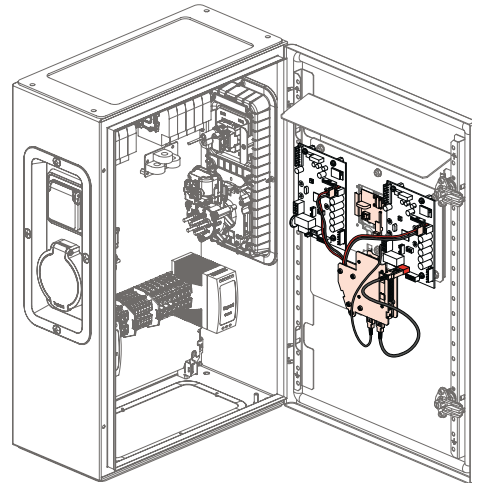

3 0 590 56 + 0 590 59 **II**

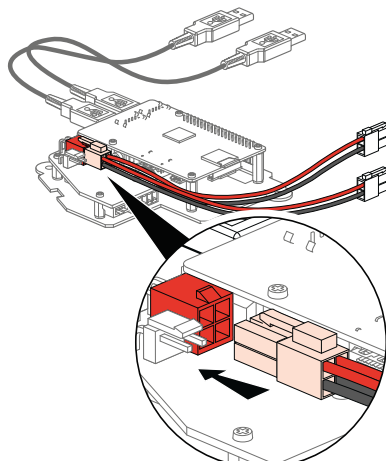

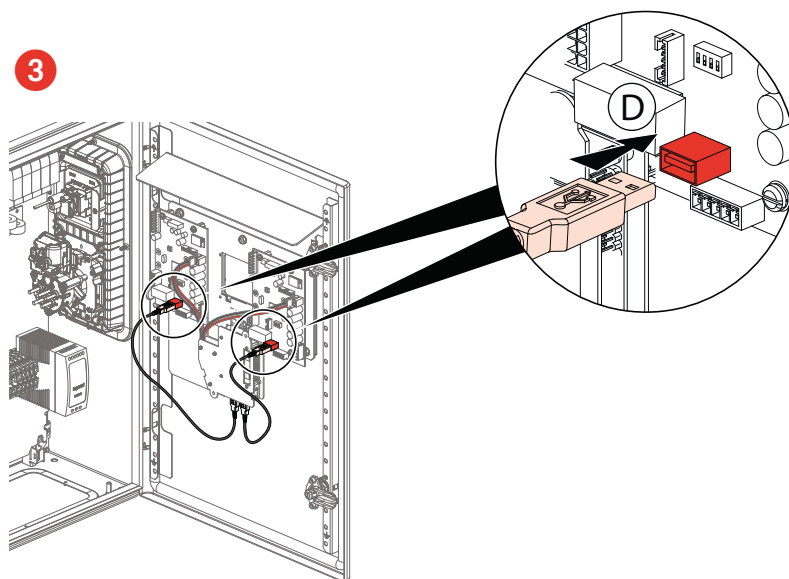
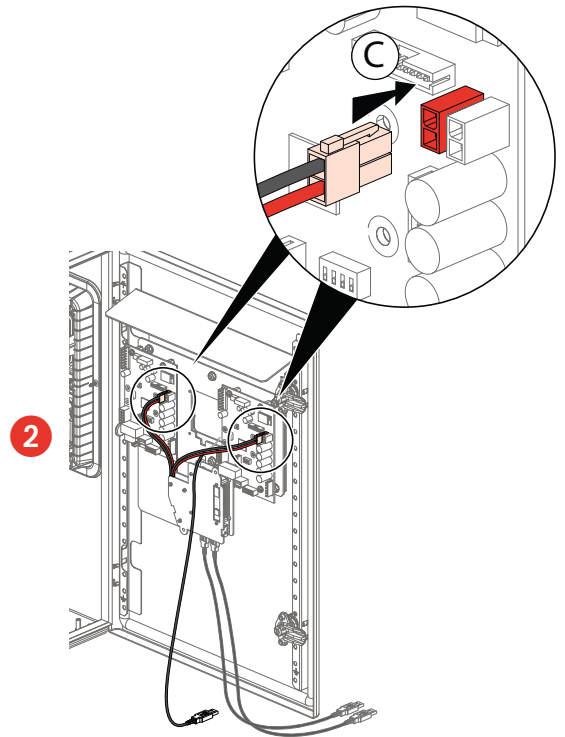
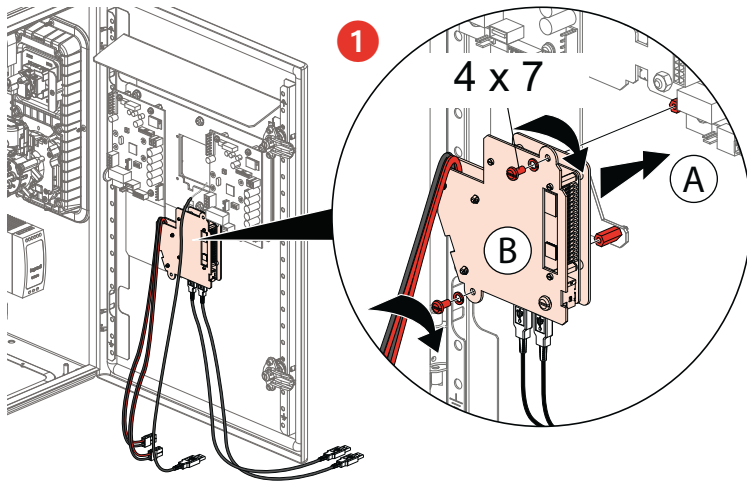



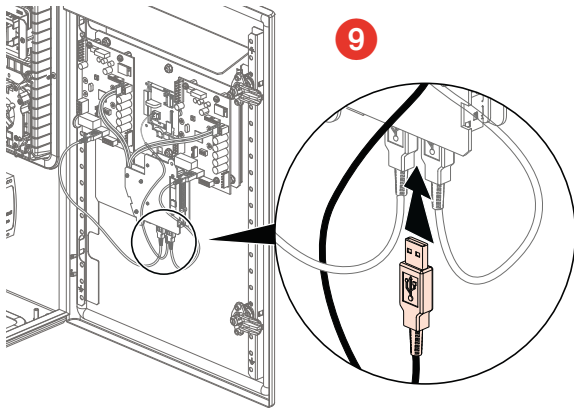
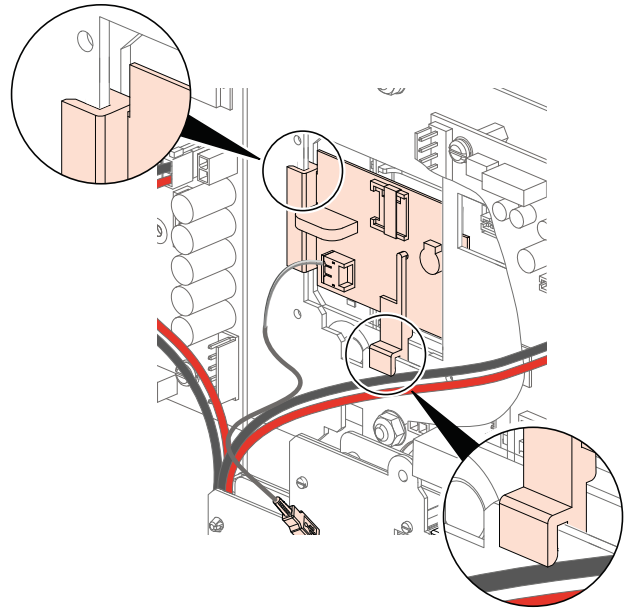
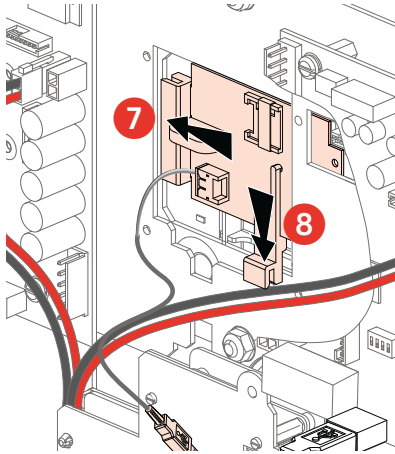
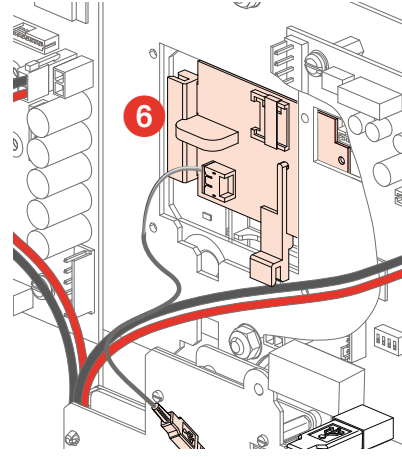
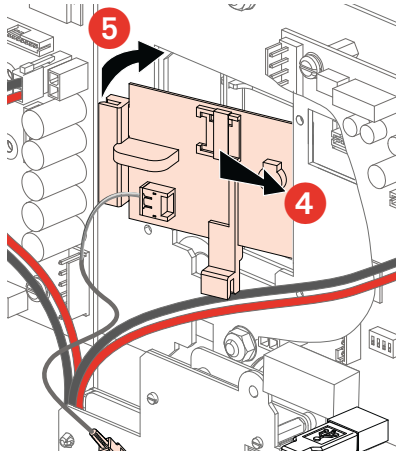

El abajo firmante LEGRAND declara que el equipo radioeléctrico del tipo (0 590 56/59) es conforme a la Directiva 2014/53/UE. El texto completo de la declaración UE de conformidad se encuentra disponible en la siguiente dirección: [www.legrand.com](http://www.legrand.com)

*O abaixo assinado, LEGRAND, declara que o equipamento radioelétrico do tipo (0 590 56/59) está em conformidade com a Diretiva 2014/53/UE.*

*O texto completo da Declaração de Conformidade UE está disponível no seguinte endereço: [www.legrand.com](http://www.legrand.com)*

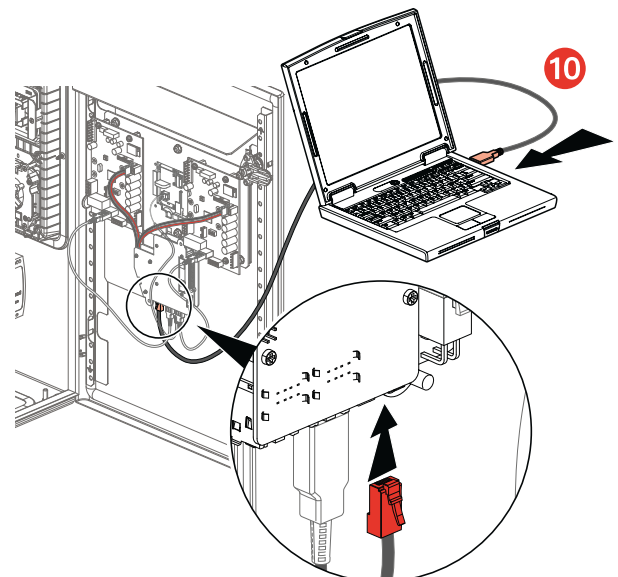



11

12

Tras la conexión del kit de comunicación, se realizará una actualización de su terminal de carga. En el momento del encendido espere aproximadamente 3 minutos antes de manipularlo/configurarlo.

Cada lado de su terminal de carga realizará automáticamente 2 reinicios durante ese proceso.

*Após a ligação do kit de comunicação, será efetuada uma atualização do terminal de carga.*

*Após a colocação sob tensão, aguardar aproximadamente 3 minutos antes de iniciar qualquer manipulação/configuração.*

*Cada lado do terminal de carga realizará automaticamente 2 reinícios durante este processo.*



Inicio del terminal  
*Inicialização do terminal*

Piloto móvil blanco a continuación piloto blanco fijo

Esperar el reinicio del terminal, a continuación

*Indicador luminoso a branco gradual e em seguida branco contínuo*

*Aguarde o reinício do terminal e em seguida*



Piloto blanco fijo OK  
*Indicador luminoso a branco contínuo OK*

13

Configuración, ver página 44

*Configuração, ver página 44*

14

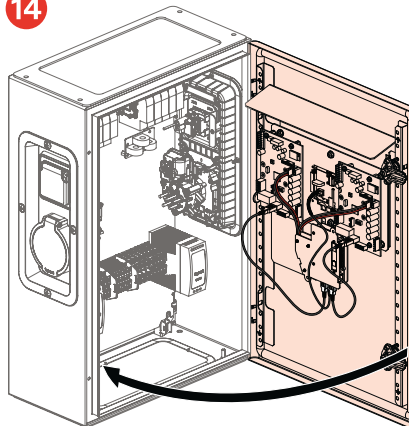



15

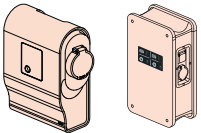
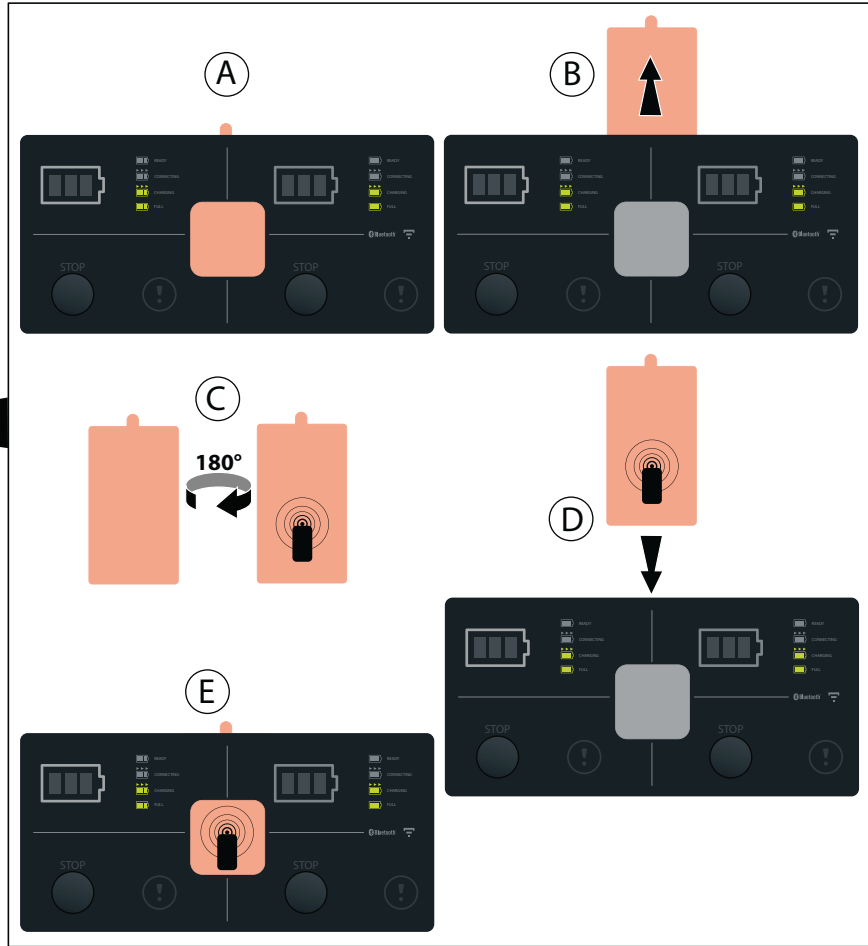
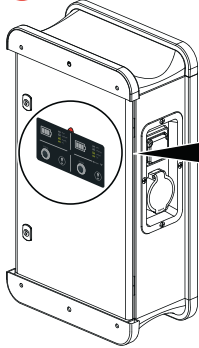

**CONEXIÓN/LIGAÇÃO 0 590 56/59**

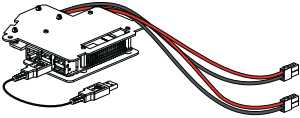
Refs.	Gestión - Páginas - Web Gestão - Páginas - Web	Aplicación EV Charge Aplicação EV charge	Modbus	OCPP
<b>0 590 56</b> 	<b>RJ 45</b> <b>o/ou</b> <b>WIFI</b>	<b>RJ 45</b> <b>o/ou</b> <b>WIFI</b>	<b>RS 485</b>	<b>RJ 45</b>

## ESQUEMA DE CONEXIÓN RJ 45/ ESQUEMA DE LIGAÇÃO RJ 45

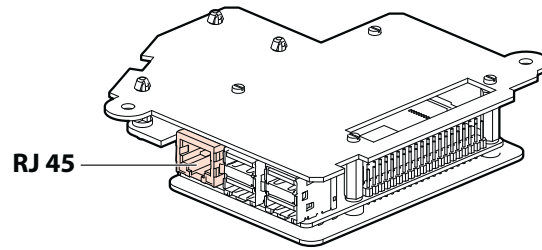

## ESQUEMA DE CONEXIÓN RS485/ESQUEMA DE LIGAÇÃO RS-485

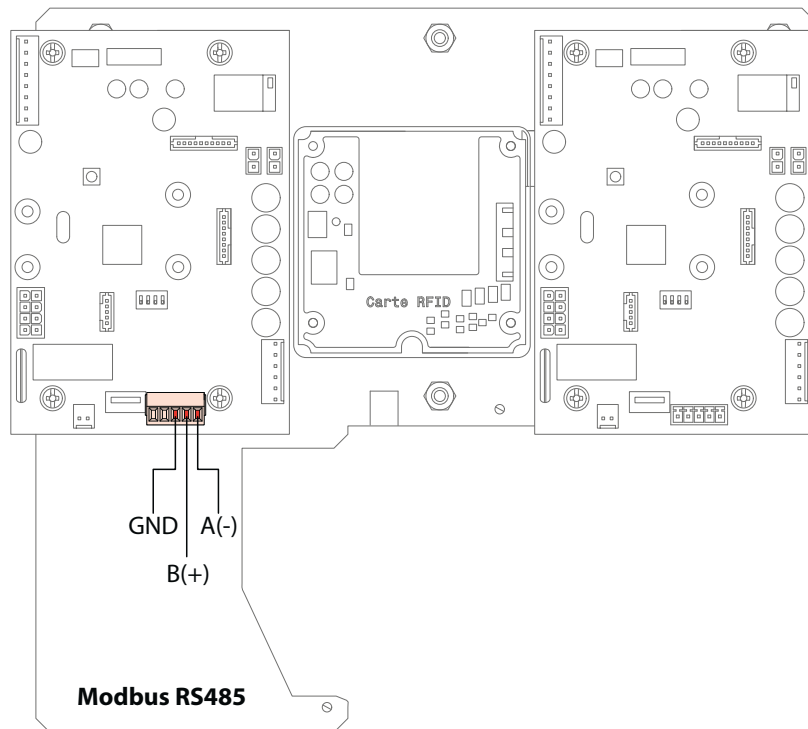

## CONFIGURACIÓN ACCESO PÁGINAS WEB

Para configuración IP, Modbus, RFID

- 1) Conectar el PC en LAN al kit Com mediante el cable RJ 45
- 2) Configurar una red local
  - a) En el centro de la red y compartición ((hacer clic en el botón iniciar (logo ver instrucciones LE08734AA-00) teclear «centro red y compartición» en la barra de búsqueda.))
  - b) Hacer clic en la conexión de la red local
  - c) Hacer clic en propiedades
  - d) Hacer clic en protocolo internet versión 4 (TCP/IP v4)
  - e) Hacer clic en propiedades
  - f) Hacer clic en utilizar la siguiente dirección IP:  
**dirección IP 192.168.1.199**  
**máscara de subred 255.255.255.0**  
**pasarela predeterminada 192.168.1.1**  
indicar los valores para dirección, máscara y pasarela
  - g) Hacer clic en OK
  - h) Abrir el navegador y teclear la dirección IP **192.168.1.200**

- 3) Pantalla formulario de conexión
  - a) Primera conexión (login y contraseña predeterminada)  
**Login : admin**  
**Contraseña: admin**
- 4) Por razones de seguridad, cambie su contraseña  
Login :  
Contraseña:

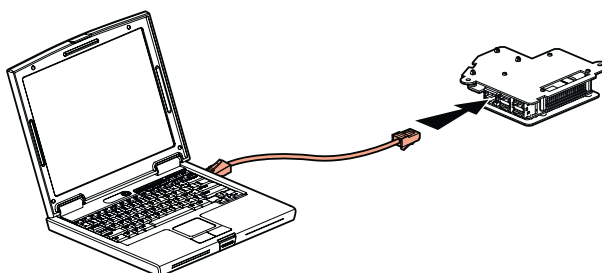

## CONFIGURAÇÃO DO ACESSO A PÁGINAS WEB

Para a configuração IP, ModBus, RFID

- 1) Ligue o PC em LAN ao kit de comunicação através do cabo RJ-45
- 2) Configure uma rede local
  - a) No Centro de Rede e Partilha (clique no botão Iniciar (logótipo, consulte as instruções LE08734AA-00), toque em "Centro de Rede e Partilha" na barra de procura).
  - b) Clique em "Ligação de área local"
  - c) Clique em "Propriedades"
  - d) Clique em "Protocolo IP Versão 4 (TCP/IPv4)"
  - e) Clique em "Propriedades"
  - f) Clicar em "Utilizar o seguinte endereço IP:"  
**endereço IP 192.168.1.199**  
**máscara de sub-rede 255.255.255.0**  
**gateway predefinido 192.168.1.1**  
introduza os valores para o endereço, a máscara e o gateway
  - g) Clique em "OK"
  - h) Abra o browser e introduza o endereço IP **192.168.1.200**

- 3) Ecrã do formulário de início de sessão
  - a) Primeira ligação (nome de utilizador e palavra-passe predefinidos)  
**Nome de utilizador: admin**  
**Palavra-passe: admin**
- 4) Por motivos de segurança, altere a sua palavra-passe  
Nome de utilizador:  
Palavra-passe:

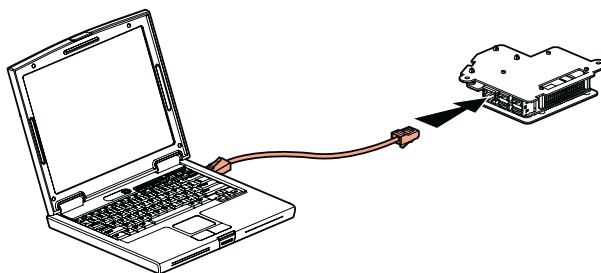

*Pantalla de inicio*



*Ecrã inicial*





**LEYENDA:**

**1- Cuadro de control**

visualizar el estado de funcionamiento del terminal por el lateral

**2- Red**

Permite configurar una red alámbrica y/o inalámbrica (WiFi)

**3- Modo de carga**

Permite seleccionar el modo de carga del terminal por el lateral

**4- Programas**

Permite gestionar la programación horaria del terminal por el lateral

**5- Acciones de ajuste**

Permite realizar acciones a distancia del terminal (intensidad, bloqueo, interrupción de carga, etc.)

**6- RFID**

Permite:

- la activación del RFID (con ref. 0 590 59)
- la gestión de las tarjetas
- la gestión del modo de funcionamiento local o a distancia

**7- Historial**

Permite descargar los historiales de carga y de errores del terminal por el lateral

**8- Información/Actualizaciones**

Permite la visualización de la información del sistema del terminal (versión software y hardware)



**Antes de realizar una puesta en servicio, descargue el manual de empleo e instale la última actualización de su kit de comunicación en [www.legrand.com](http://www.legrand.com)**

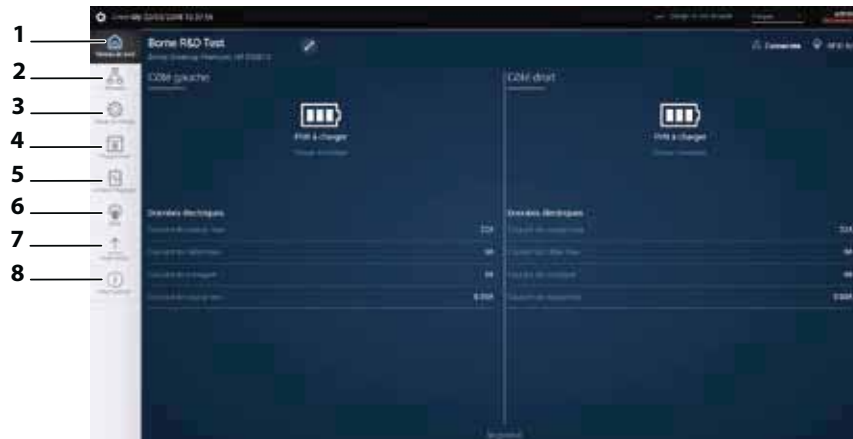

**LEGENDA:**

**1- Dashboard**

Permite visualizar o estado de funcionamento do terminal por lado

**2 - Rede**

Permite configurar uma rede com e/ou sem fios (Wi-Fi)

**3 - Modo de carga**

Permite escolher o modo de carga do terminal por lado

**4 - Programas**

Permite gerir a programação horária do terminal por lado

**5 - Ações de regulação**

Permite efetuar ações remotas no terminal (intensidade, bloqueio, paragem de carga, etc.)

**6- RFID**

Permite:

- Ativação do RFID (com ref. 0 590 59)
- Gestão dos distintivos
- Gestão do modo de funcionamento local ou remot

**7 - Histórico**

Permite transferir os históricos de carga e de erros do terminal por lado

**8 - Informações/Atualizações**

Permite visualizar informações do sistema do terminal (versão do software e hardware)



**Antes da primeira colocação em serviço, transfira o manual de utilização e instale a atualização mais recente do seu kit de comunicação em [www.legrand.com](http://www.legrand.com)**

### 1. Archivado local de las tarjetas en el terminal:

Conectarse al kit de comunicación:

Abrir la pestaña RFID

Activar el lector RFID

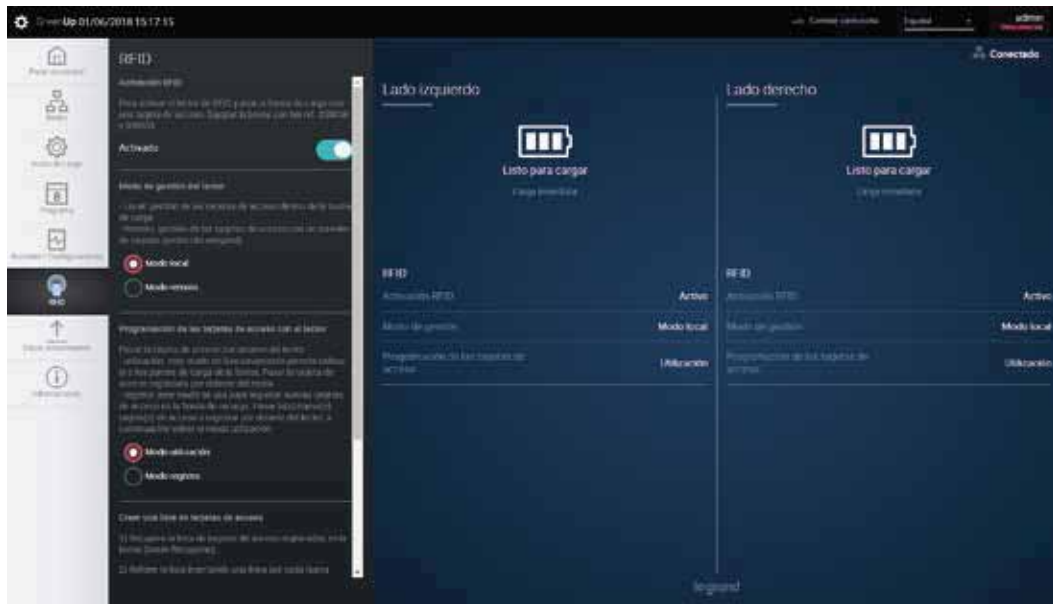

Seleccionar «Modo local»

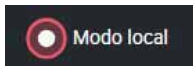

### 1. Registo local dos distintivos no terminal:

Estabelecer ligação ao kit de comunicação:

Abra o separador RFID

Ative o leitor RFID

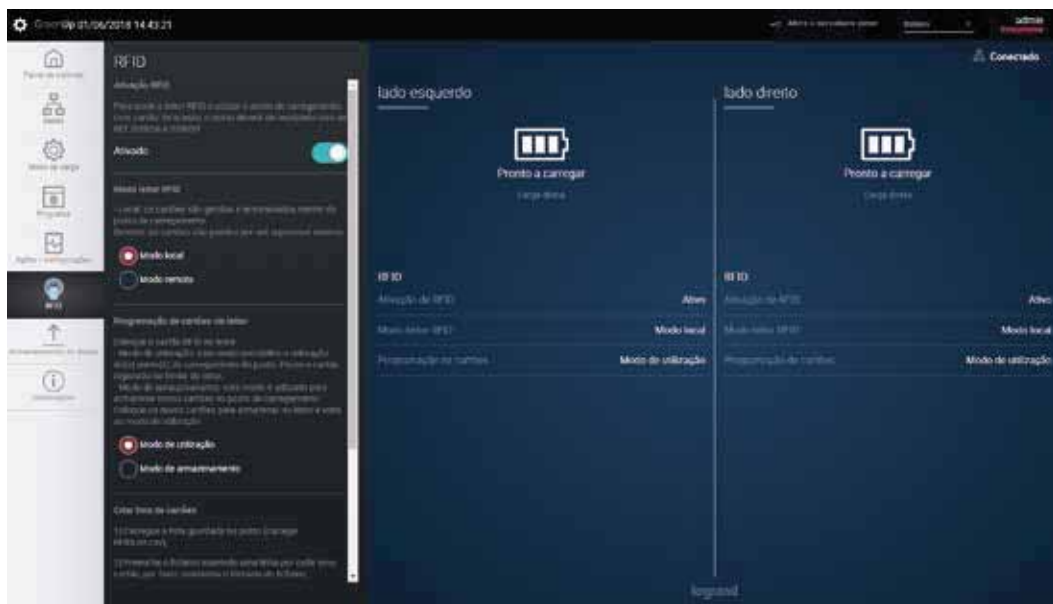

Selecione "Modo local"

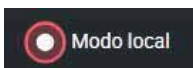

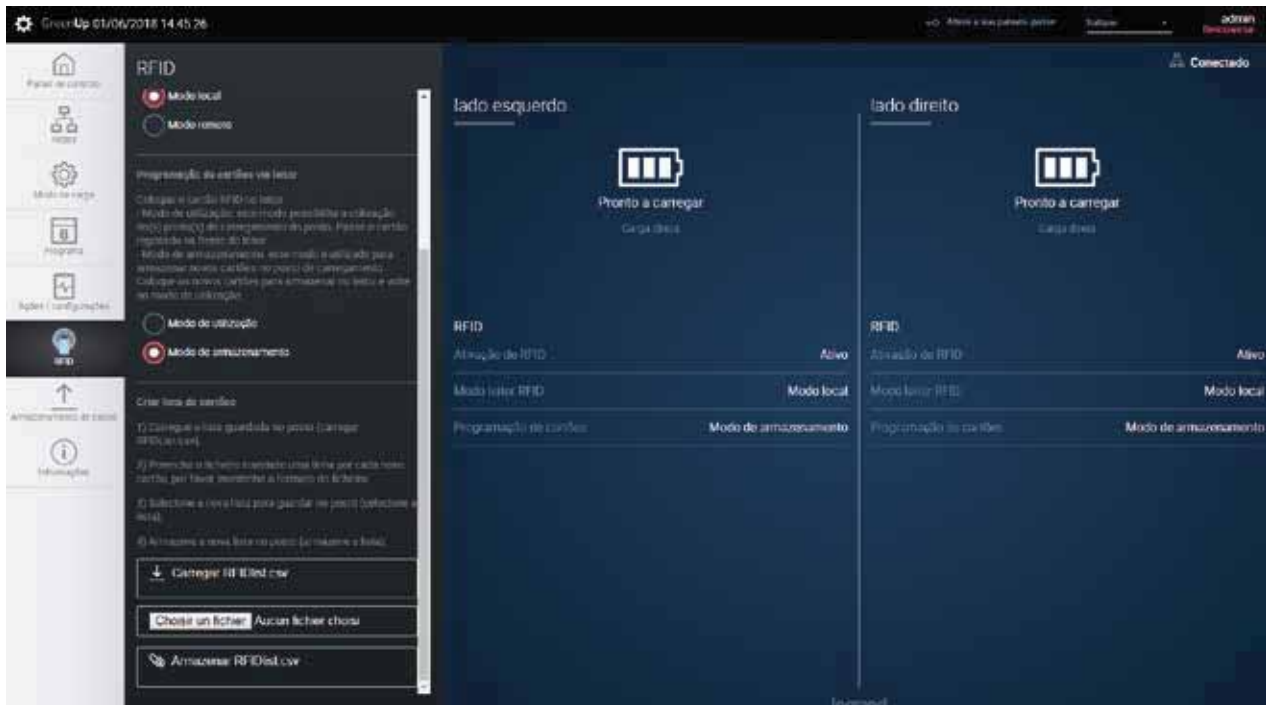
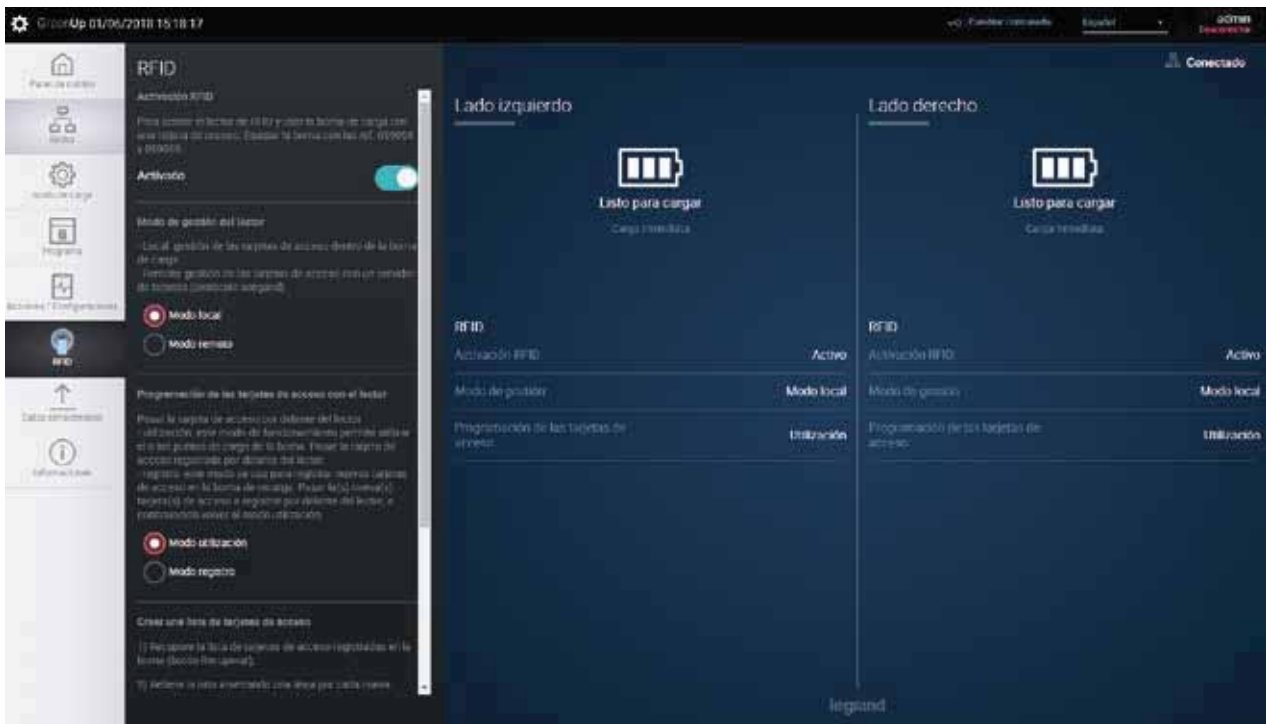



## Seleccionar «Modo registro»

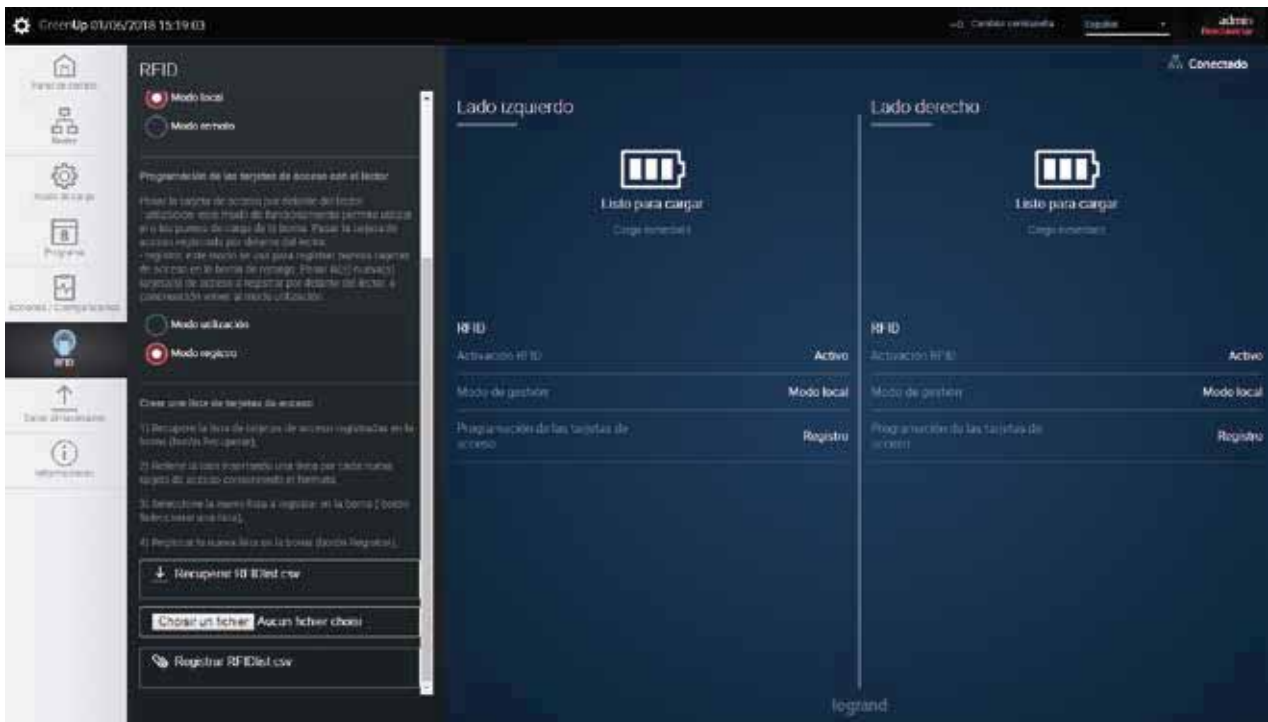
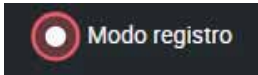

## Selezione “Modo de almacenamiento”

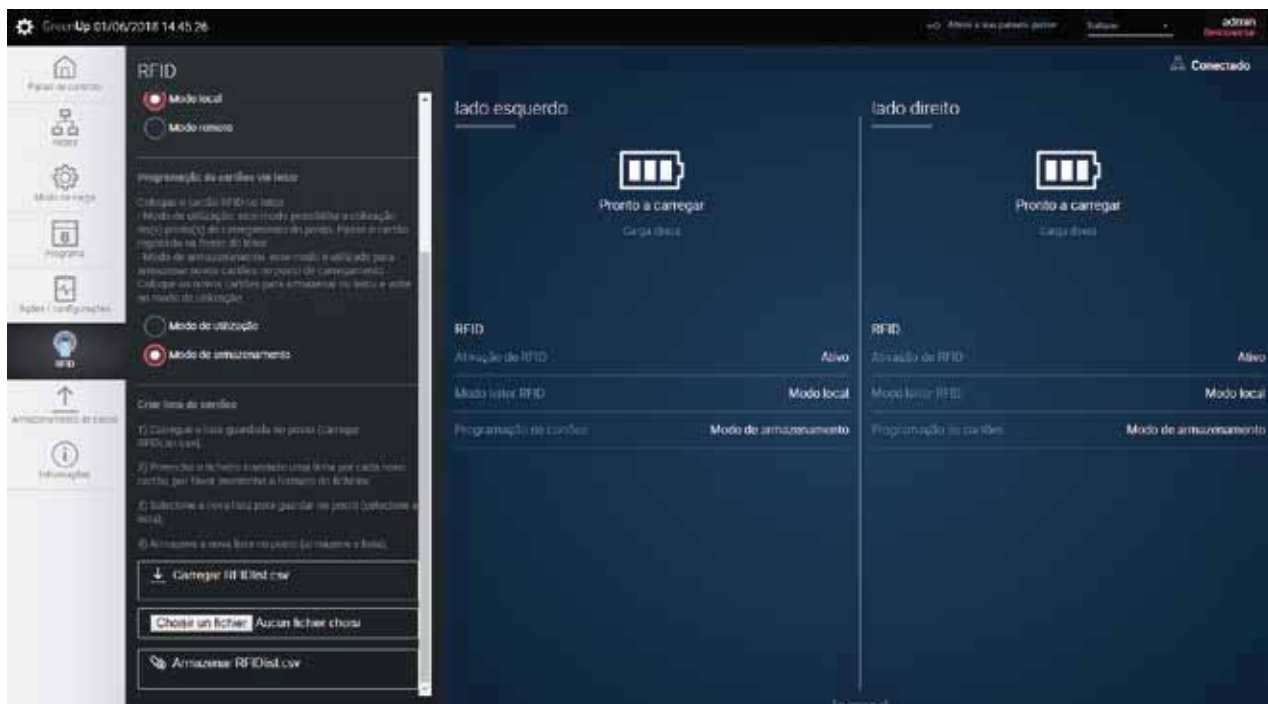
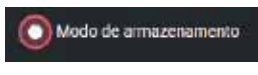

A continuación dirigirse al terminal: Secuencia en blanco de los pilotos en la interfaz  
 ⇒ El terminal está preparado para archivar las tarjetas  
 Pasar el distintivo a archivar ante el lector RFID: movimiento de los pilotos en verde  
 ⇒ La tarjeta queda archivada  
 Repetir la operación tantas veces como tarjetas a archivar  
 Finalizado el archivado de las tarjetas, volver al modo utilización

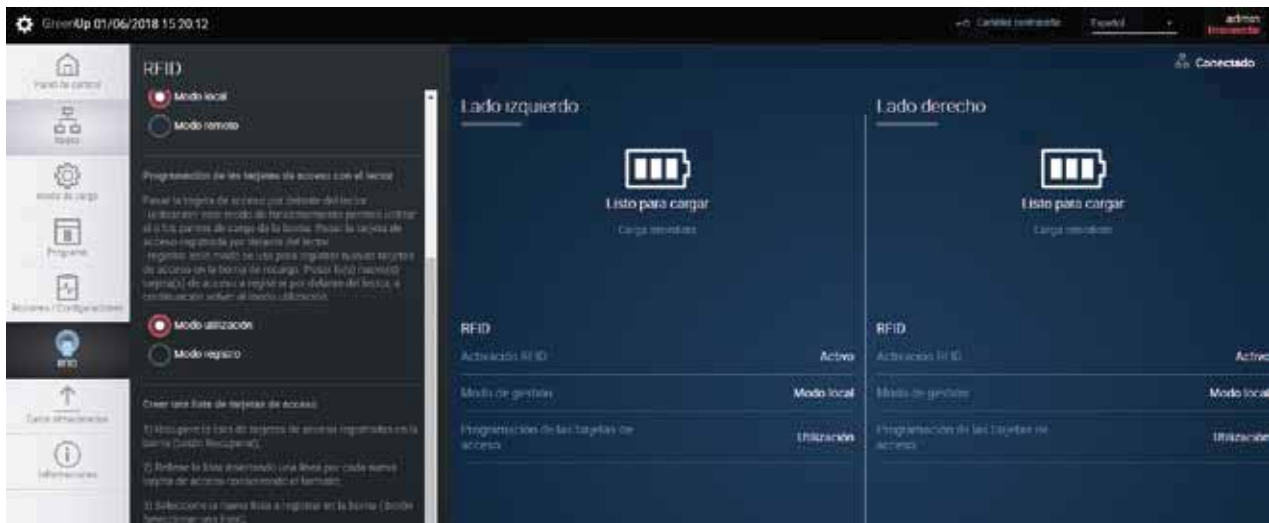

**Observación:** Si se pasa ante un terminal una tarjeta ya archivada, se producirá una intermitencia en rojo

Em seguida, fique em frente ao terminal: Progressão gradual a branco dos indicadores luminosos na interface  
 ⇒ O terminal está pronto para registrar os distintivos  
 Passe o distintivo a registrar em frente ao leitor RFID: progressão gradual a verde dos indicadores luminosos  
 ⇒ O distintivo é registado  
 Repita a operação o número de vezes que for necessário para registrar todos os distintivos  
 No fim do registo dos distintivos, volte ao modo de utilização

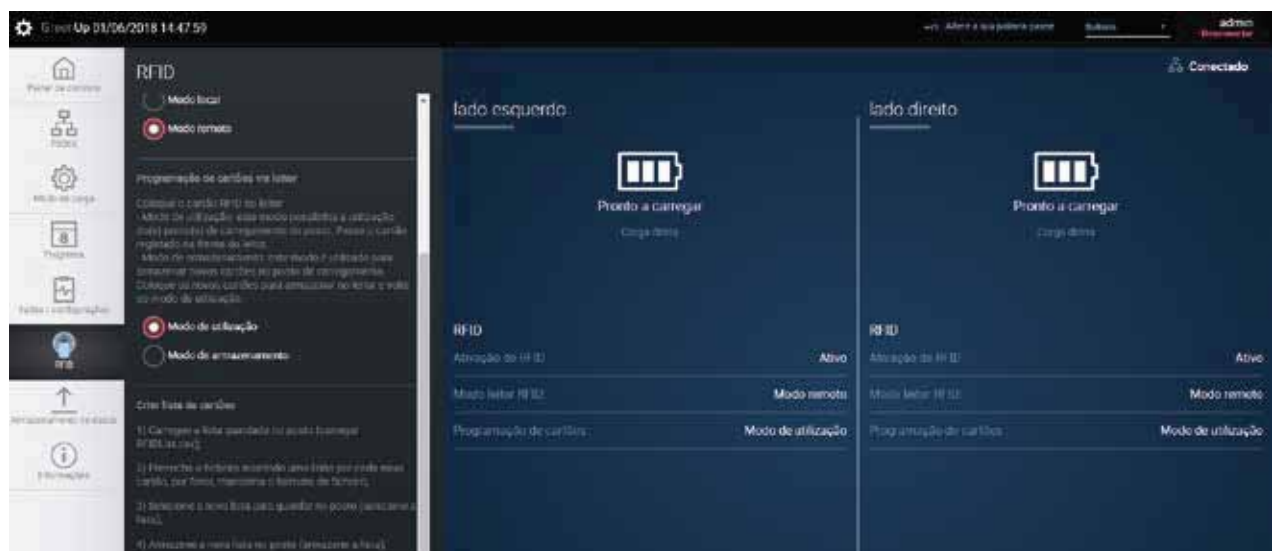

**Nota:** se for passado em frente ao terminal um distintivo já registado, ocorre uma intermitência a vermelho

## 2. Creación y utilización de una lista de tarjetas

Conectarse al kit de comunicación:

Abrir la pestaña RFID

Activar el lector RFID



Seleccionar «Modo local»

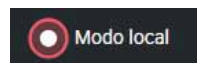

Seleccionar «Modo registro»



## 2. Criação e utilização de uma lista de distintivos

Estabelecer ligação ao kit de comunicação:

Abra o separador RFID

Ative o leitor RFID

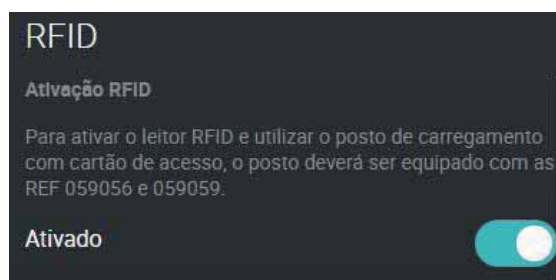

Selecione "Modo local"

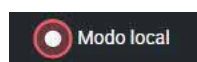

Selecione "Modo de armazenamento"

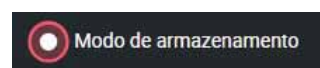

Ejemplo de lista de tarjetas:

Respetar rigurosamente el siguiente formato  
(fechas y apellidos opcionales):

Date	Id	Name
26/02/2018 08:40	2000236672	Dupont
26/02/2018 08:39	2000243520	Durand
26/02/2018 08:39	1997833664	Martin

End

a) Creación de una lista de tarjetas:

- crear un archivo RFIDList.csv según las siguientes condiciones
- completar con los datos de los distintivos, y eventualmente los apellidos y las fechas correspondientes
- Hacer clic en «+ Añadir una lista de tarjetas de acceso» para seleccionarlo

+ Añadir una lista de tarjetas de acceso No se ha seleccionado ningún archivo

- Hacer clic en «registrar RFIDList.csv»

 Registrar RFIDlist.csv

⇒ Su lista de tarjetas ha sido archivada

b) Edición de una lista de tarjetas:

- Hacer clic en «recuperar RFIDList.csv»

 Recuperar RFIDlist.csv

c) Modificación de una lista de tarjetas

- Hacer clic en «registrar RFIDList.csv»

 Registrar RFIDlist.csv

- Realizar las modificaciones en el archivo  
(adiciones, eliminaciones, cambios de usuario)

- Guardar las modificaciones

- Hacer clic en «seleccionar un archivo» para seleccionarlo

- Hacer clic en «archivar RFIDList.csv»

 Registrar RFIDlist.csv

⇒ Su nueva lista de distintivos ha sido archivada

Exemplo de lista de distintivos:

Respeite absolutamente o formato abaixo  
(datas e nomes opcionais):

Date	Id	Name
26/02/2018 08:40	2000236672	Dupont
26/02/2018 08:39	2000243520	Durand
26/02/2018 08:39	1997833664	Martin

End

a) Criação de uma lista de distintivos:

- Crie um ficheiro *RFIDList.csv* de acordo com as condições indicadas acima
- Complete com os dados de distintivos e eventualmente os nomes e datas correspondentes
- Clique em "+ Adicionar lista de cartões" para seleccioná-lo

+ Adicionar lista de cartões Nenhum ficheiro selecionado

- Clique em "Armazenar *RFIDList.csv*"

📎 Armazenar *RFIDlist.csv*

⇒ A sua lista de distintivos está guardada

b) Edição de uma lista de distintivos:

- Clique em "Carregar *RFIDList.csv*"

↓ Carregar *RFIDlist.csv*

c) Alteração de uma lista de distintivos:

- Clique em "Armazenar *RFIDList.csv*"

📎 Armazenar *RFIDlist.csv*

- Efetue as alterações pretendidas no ficheiro  
(adições, eliminações, alteração de utilizador)

- Guarde as alterações

- Clique em "Selecionar um ficheiro" para seleccioná-lo

- Clique em "Armazenar *RFIDList.csv*"

📎 Armazenar *RFIDlist.csv*

⇒ A sua lista de distintivos está guardada

### 3. Utilización del lector de tarjetas con una gestión centralizada

Conectarse al kit de comunicación:

Abrir la pestaña RFID

Activar el lector RFID

Seleccionar «Modo a distancia»

(utilización del protocolo de comunicación Wiegand)

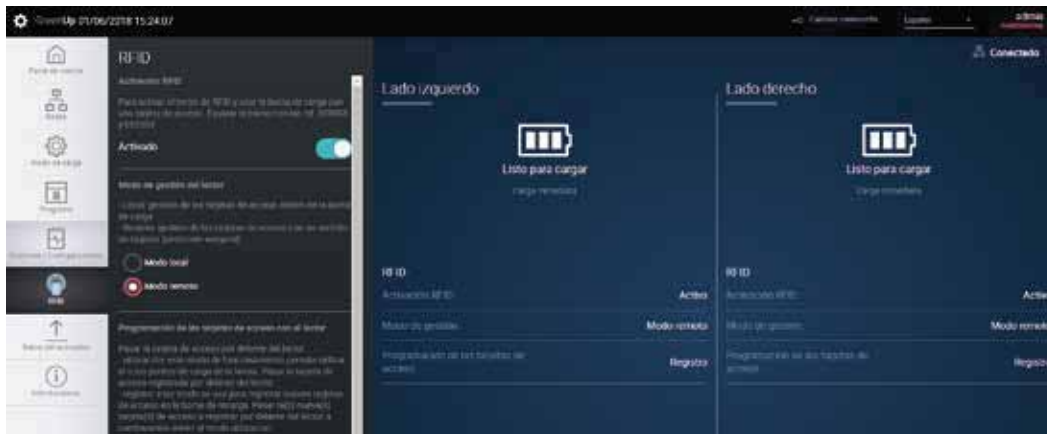
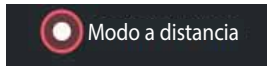

### 3. Utilização do leitor de distintivos com uma gestão centralizada

Estabelecer ligação ao kit de comunicação:

Abra o separador RFID

Ative o leitor RFID

Selecione “Modo remoto”

(utilização do protocolo de comunicação Wiegand)

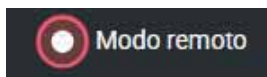

#### 4. Utilización del terminal con tarjetas RFID

Activar el lector RFID

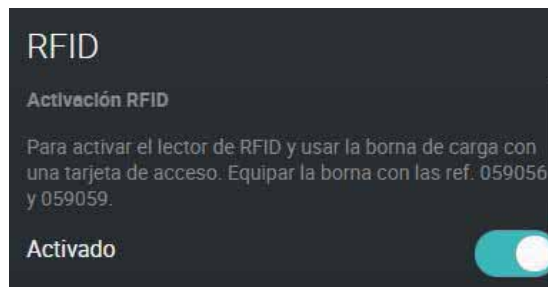

En la pestaña RFID, pasar al modo utilización

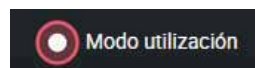

Según el orden de las operaciones

a) Conectar el cable al terminal

Pasar el distintivo ante el terminal

Los pilotos blancos parpadean en el lado del cable => se inicia la carga

b) Pasar la tarjeta ante el terminal:

los pilotos verdes parpadean

Conectar el cable (duración máxima:

1 minuto, si supera este tiempo volver a pasar la tarjeta ante el terminal)

5. Se inicia la carga

##### **Badge non enregistré :**

Si se pasa una tarjeta no archivada ante el terminal:

intermitencia «flash» de los pilotos rojos

#### 4. Utilização do terminal com crachás RFID

Ative o leitor RFID

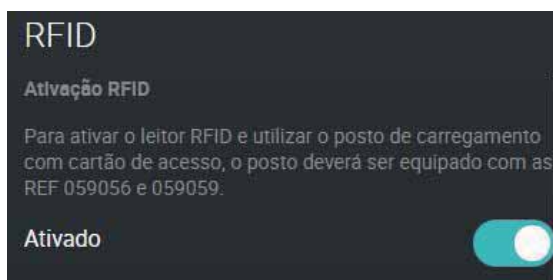

No separador RFID, passe para o modo de utilização

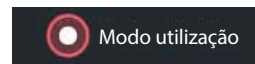

Seguindo a ordem das operações

a) Ligue o cabo ao terminal

Passe o distintivo em frente ao terminal

Os indicadores luminosos brancos piscam do lado do cabo => A carga arranca

b) Passe o seu distintivo em frente ao terminal:

os indicadores luminosos verdes piscam

Ligue o cabo (duração máxima: 1 minuto;

acima de 1 minuto, volte a passar o distintivo em frente ao terminal)

5. A carga arranca

##### **Distintivo não registado:**

se for passado um distintivo não registado em frente ao terminal:

intermitência "flash" dos indicadores luminosos vermelhos



**A descargar en**  
**Para transferir em**  
**www.legrand.com**  
**LE10817AA-01 (FR)**  
**LE10990AA-01 (EN)**

**BORNES GREEN'UP PREMIUM**  
**TERMINAIS GREEN'UP PREMIUM**  
**Manual de empleo**  
**Manual de utilização**  
**Kit de comunicación y lector RFID**  
**Kit de comunicação e leitor RFID**



 **Istruzioni di sicurezza / Veiligheidsvoorschriften**

 **DEEE**

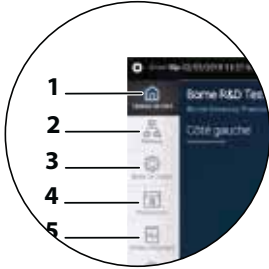

Configurazione accesso pagine WEB ..... p 72  
 Configuratie van toegang tot WEB-pagina's ..... p 72

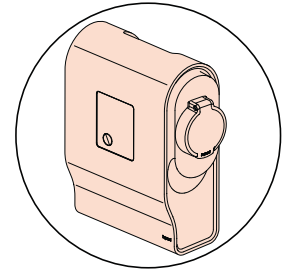

Installazione/Installatie  
 0 590 56 ..... p 58

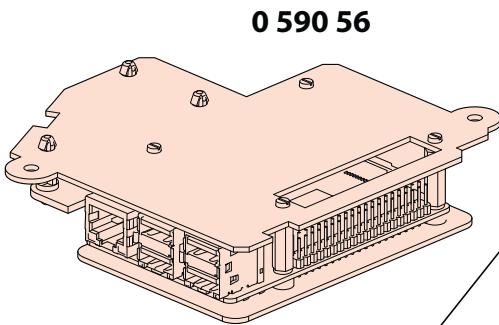

**0 590 56**

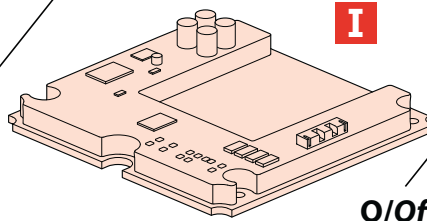

**0 590 59**

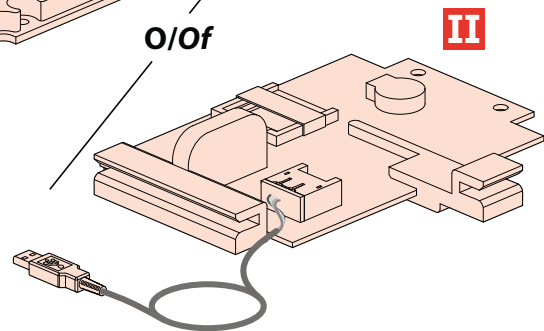

**O/Of**

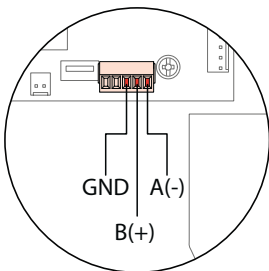

Collegamento ..... p 70  
 Aansluiting ..... p 70

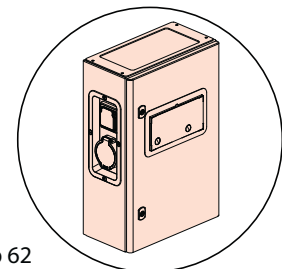

Installazione/Installatie  
 0 590 56 o/of  
 0 590 56 + 0 590 59 ..... p 62



0 590 56

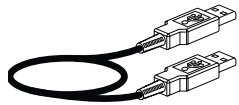
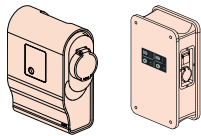

x 2

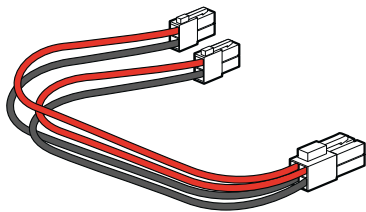
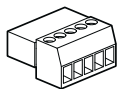
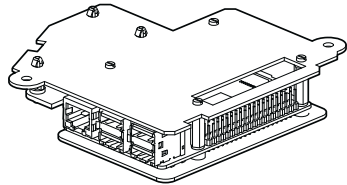

M4 x 7  
x 2

4 x 12  
x 2

0 590 59

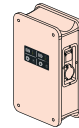

I

O/Of

II

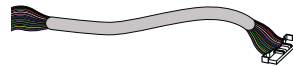

x 4

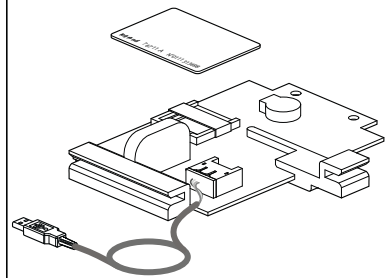
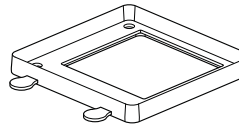
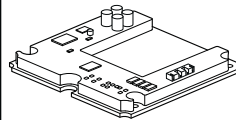
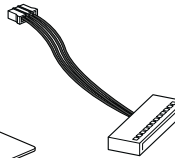

**Prima di effettuare qualsiasi intervento, togliere la corrente.  
Rispettare scrupolosamente le condizioni di installazione e d'uso.  
Vóór iedere ingreep de stroom uitschakelen.  
De installatie- en gebruiksvoorwaarden nauwgezet in acht nemen.**

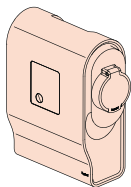

+ 0 590 56

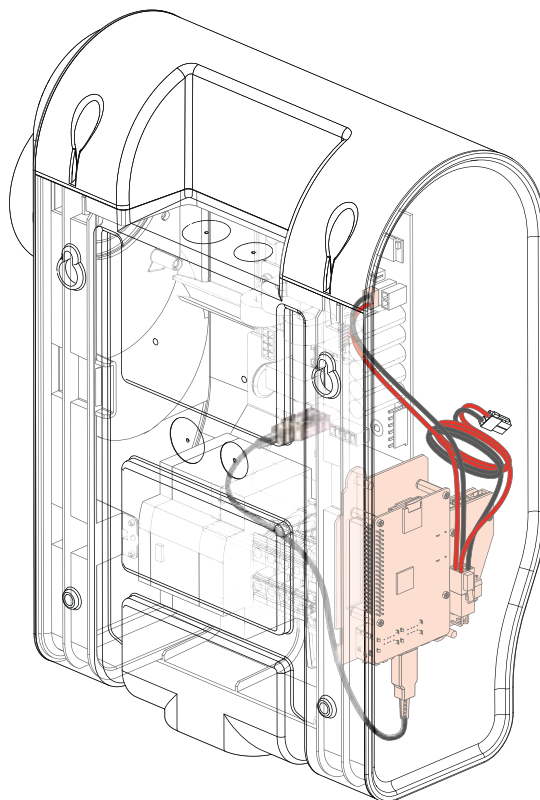

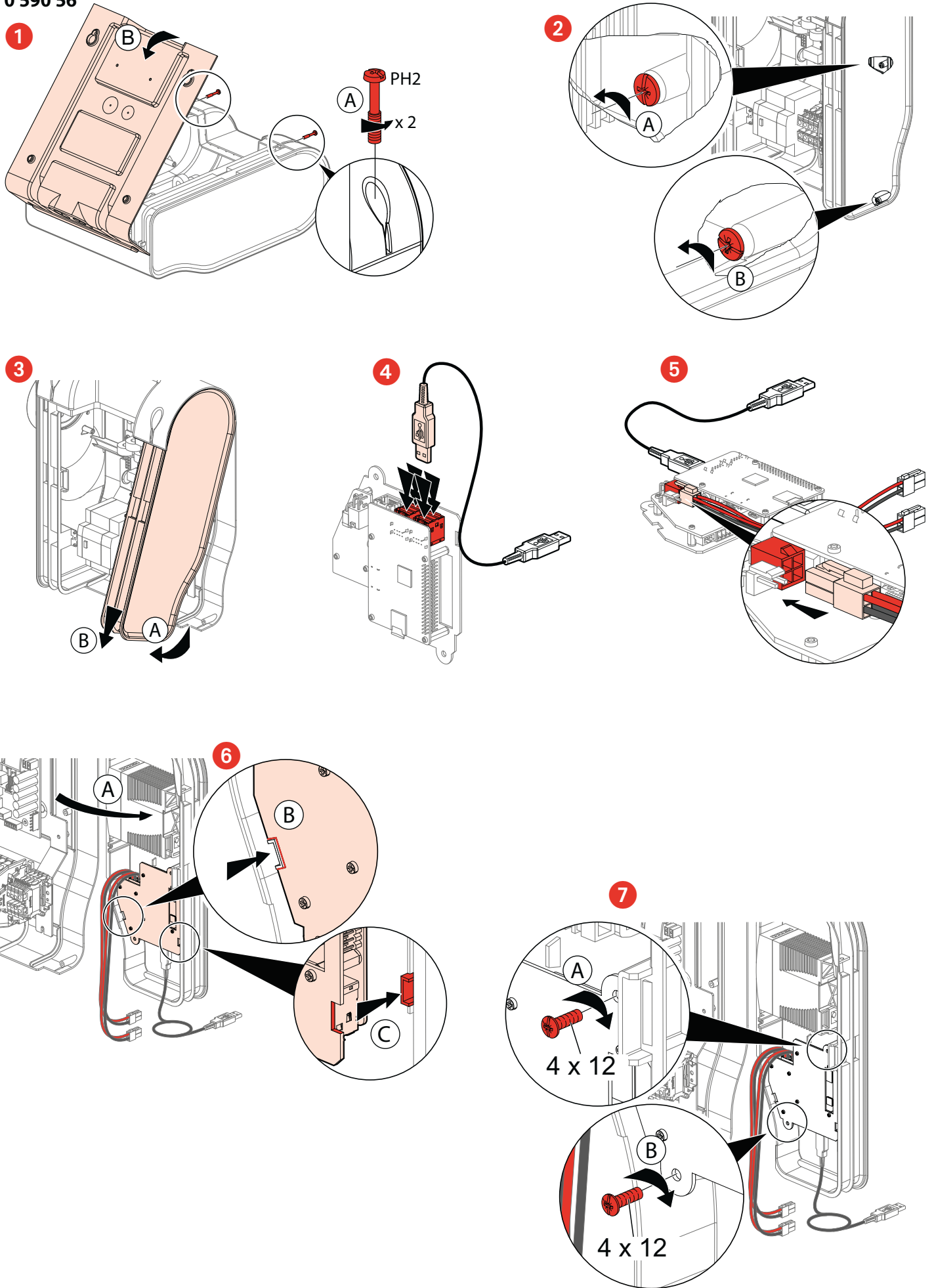

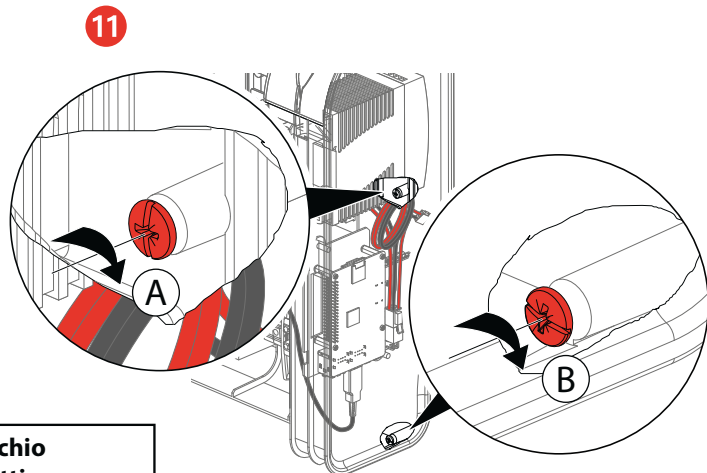
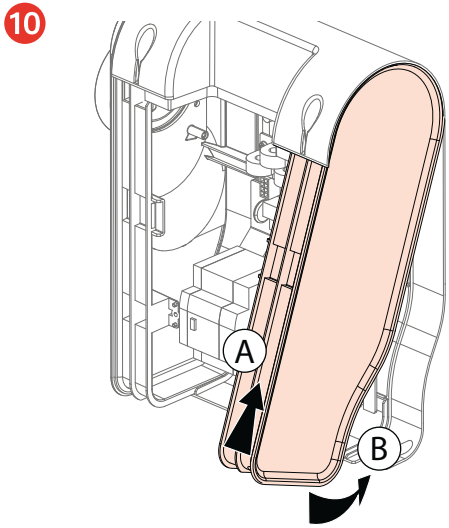
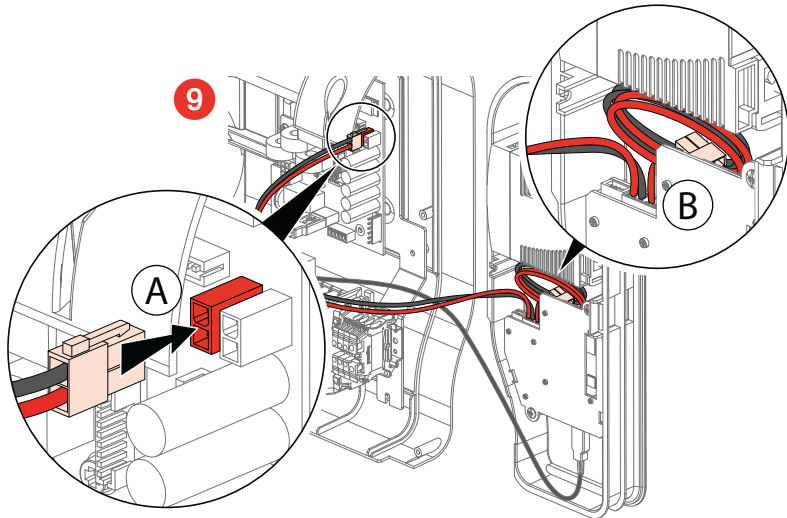
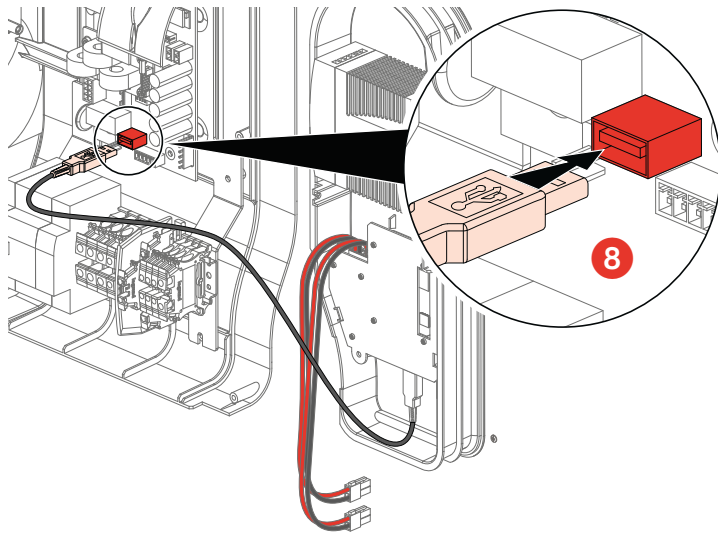

La sottoscritta società **LEGRAND** dichiara che l'apparecchio radioelettrico di tipo (0 590 56/59) è conforme alla Direttiva 2014/53/UE. Il testo completo della dichiarazione di conformità UE è disponibile al seguente indirizzo: [www.legrand.com](http://www.legrand.com)

Ondergetekende, **LEGRAND**, verklaart dat de radioapparatuur van het type (0 590 56/59) conform is met Richtlijn 2014/53/EU. De volledige tekst van de EU-conformiteitsverklaring is beschikbaar op het volgende adres: [www.legrand.com](http://www.legrand.com)

12

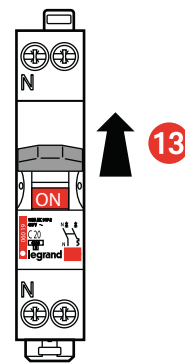
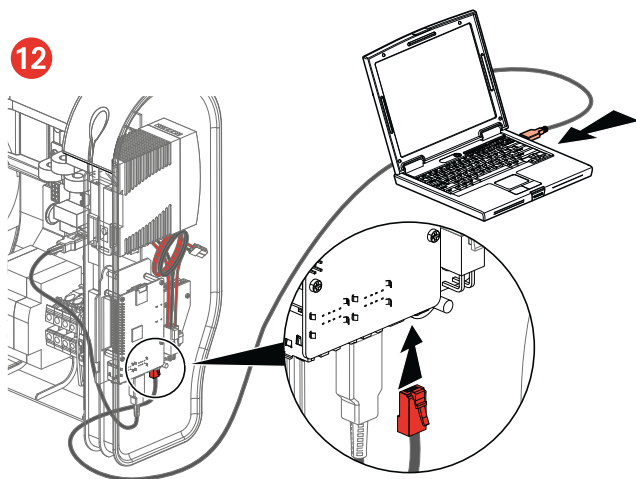

13

14

Dopo il collegamento del kit di comunicazione, si effettuerà un aggiornamento della stazione di ricarica.  
 Dopo l'accensione, attendere circa 3 minuti prima di qualsiasi manipolazione/configurazione.  
 Ogni lato della stazione di ricarica effettuerà automaticamente 2 riavvii durante questo processo.  
*Na aansluiting van de communicatiekit wordt een update van de laadpaal uitgevoerd..*  
*Na inschakeling, ongeveer 3 minuten wachten alvorens een bewerking/configuratie uit te voeren.*  
*Gedurende die tijd zal iedere zijde van de laadpaal automatisch 2 keer opnieuw opstarten.*



Inizializzazione della stazione  
*Initialisatie van de laadpaal*

Spia luminosa bianca scorrevole poi spia luminosa bianca fissa  
*Wit scrollen van controlelampjes, dan continu wit*  
 Aspettare il riavvio della stazione poi  
*Wachten tot opnieuw opstarten van de laadpaal en dan*

**Nota: per la configurazione, vedere pagina 72**  
**Opmerking: voor de configuratie zie pagina 72**

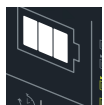

Spia luminosa bianca fissa OK  
*Controlelampjes continu wit OK*

15

Ingresso di cavi per collegamento a filo (RJ45),  
 vd. pag. 3 del libretto di istruzioni della vostra stazione di ricarica n° LE09745AA  
*Kabelingangen voor aansluiting van draadverbindingen (RJ45),*  
*zie bladzijde 3 van de instructie van uw oplaadpaal Nr. LE09745AA*

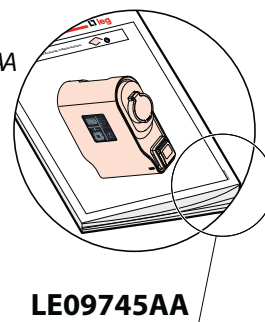

LE09745AA

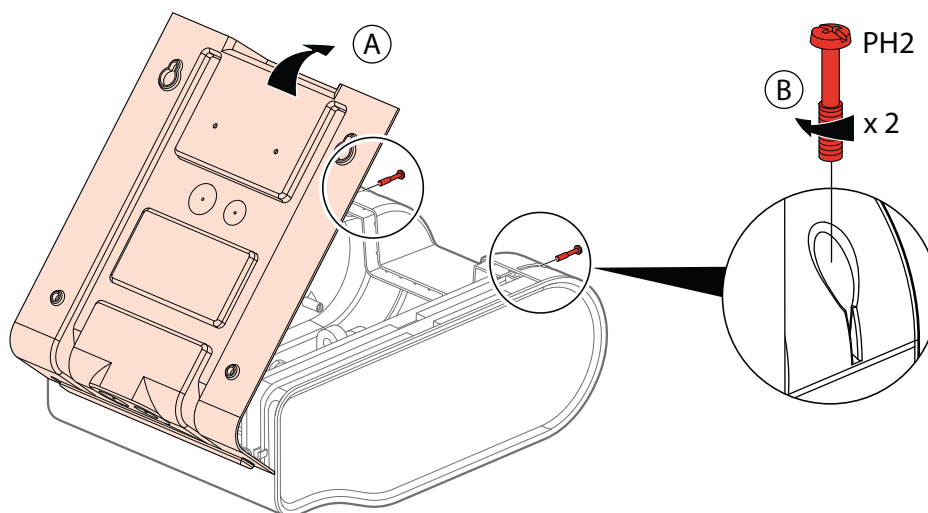





**Prima di effettuare qualsiasi intervento, togliere la corrente.**  
**Rispettare scrupolosamente le condizioni di installazione e d'uso.**  
**Vóór iedere ingreep de stroom uitschakelen.**  
**De installatie- en gebruiksvoorwaarden nauwgezet in acht nemen.**

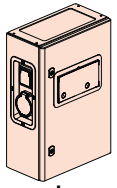

+

**0 590 56**

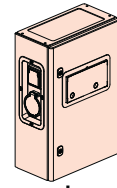
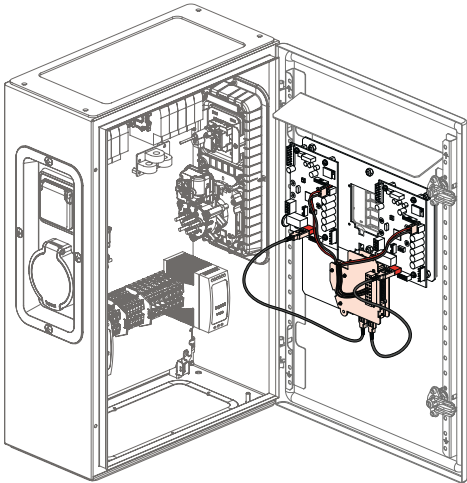

+

**0 590 56**

+

**0 590 59 I**

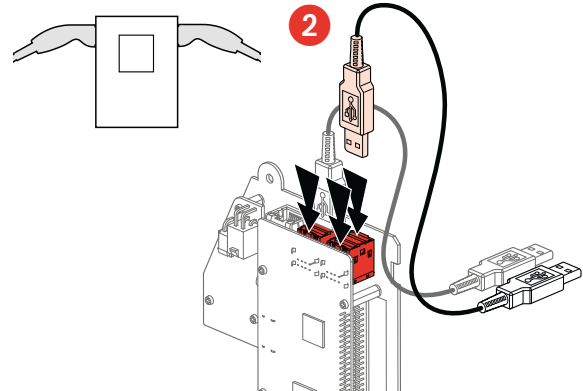
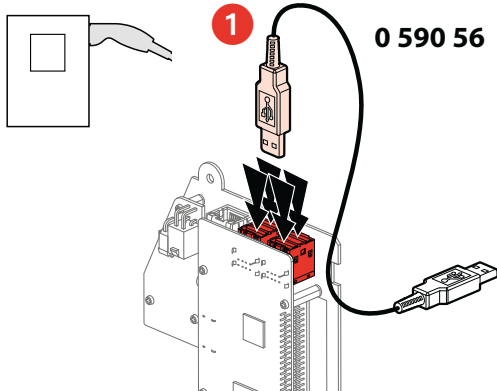
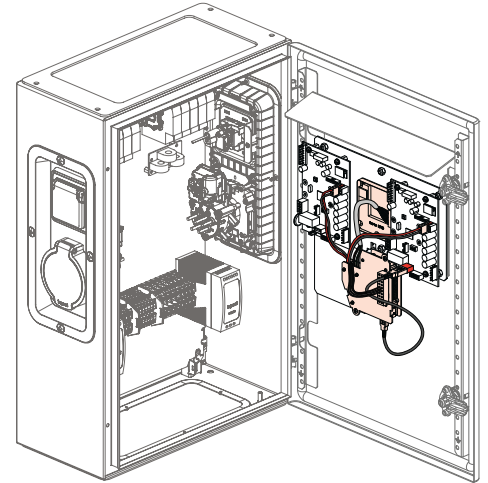

**0 590 56 + 0 590 59 I**

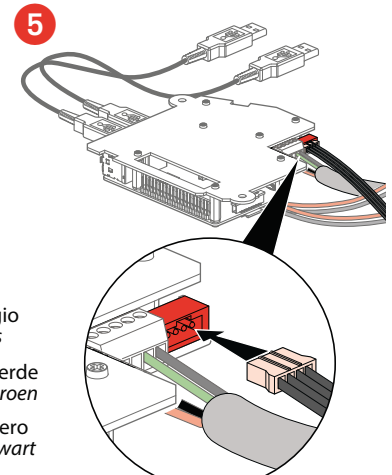
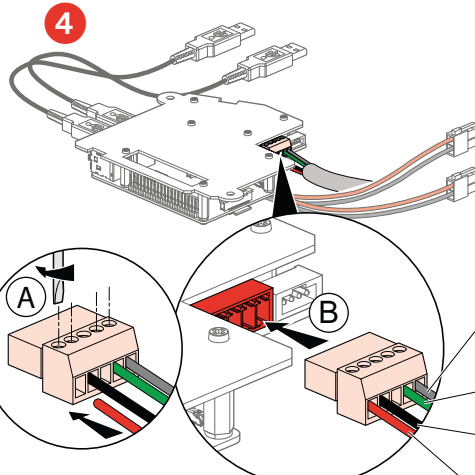
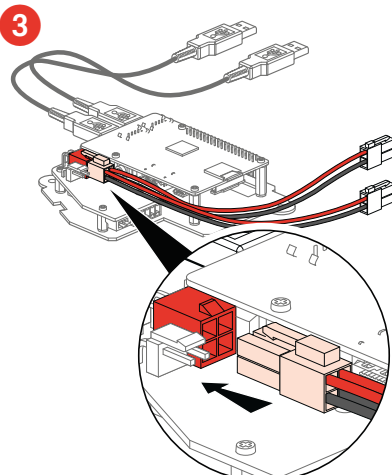

Grigio  
Grijs  
Verde  
Groen  
Nero  
Zwart  
Rosso  
Rood



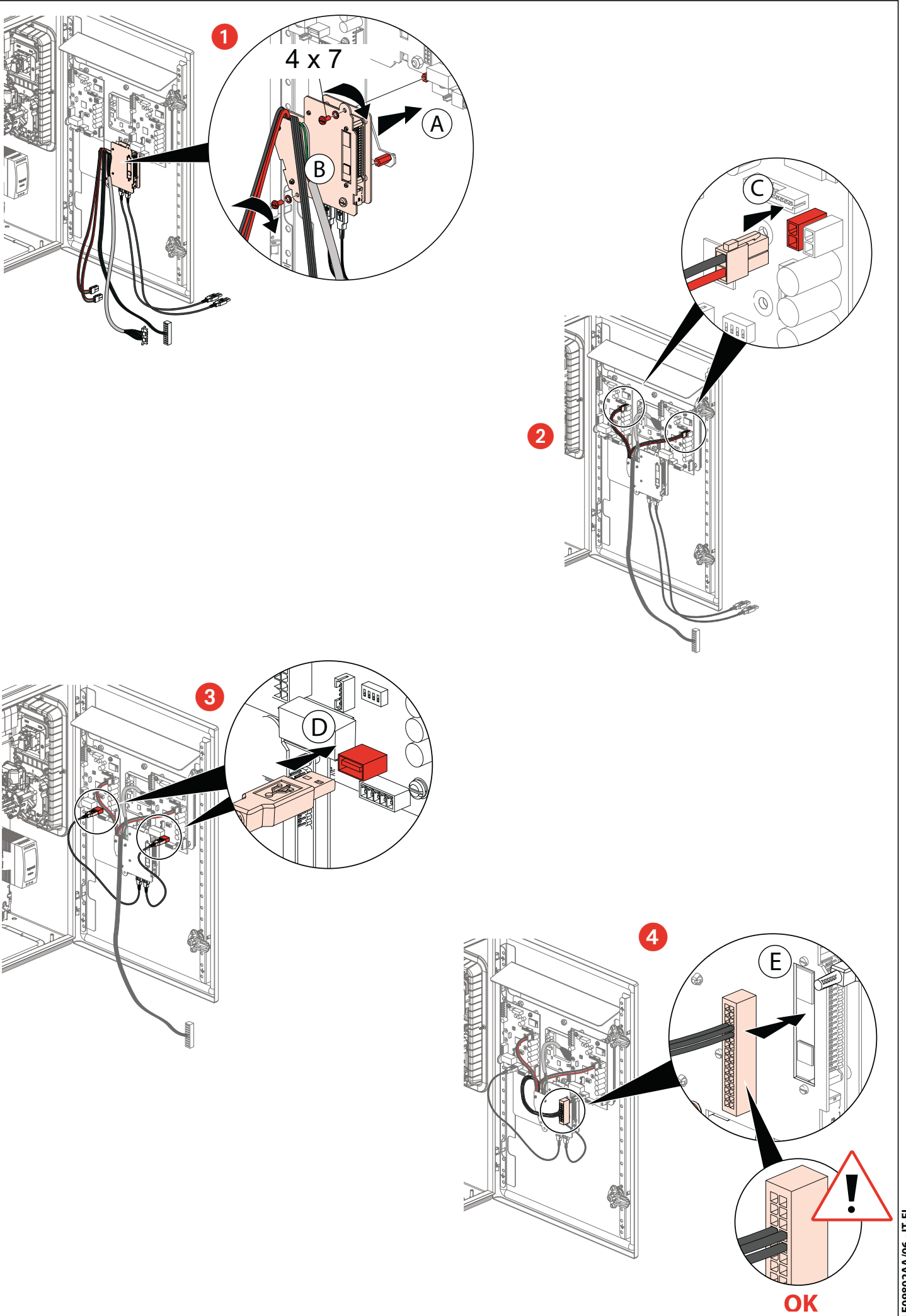

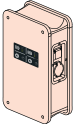

+ 0 590 59 **I**

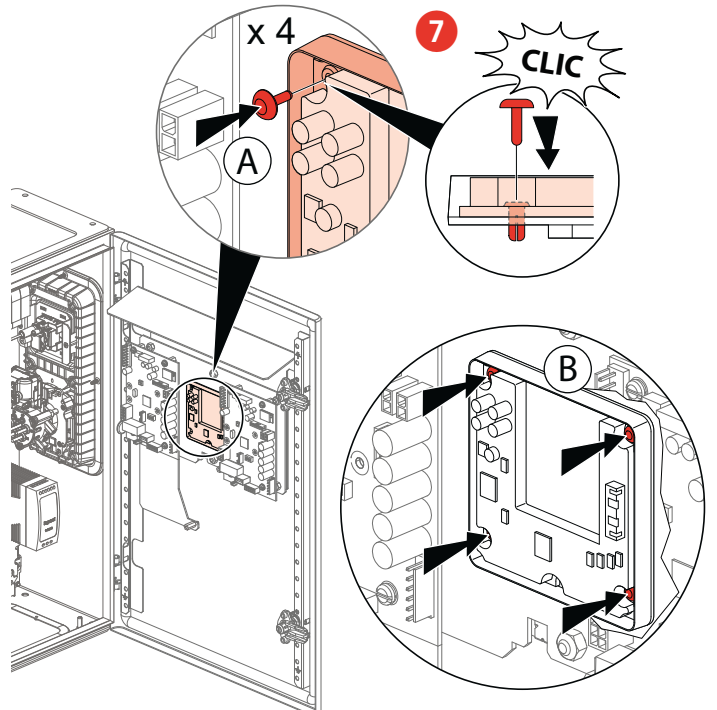
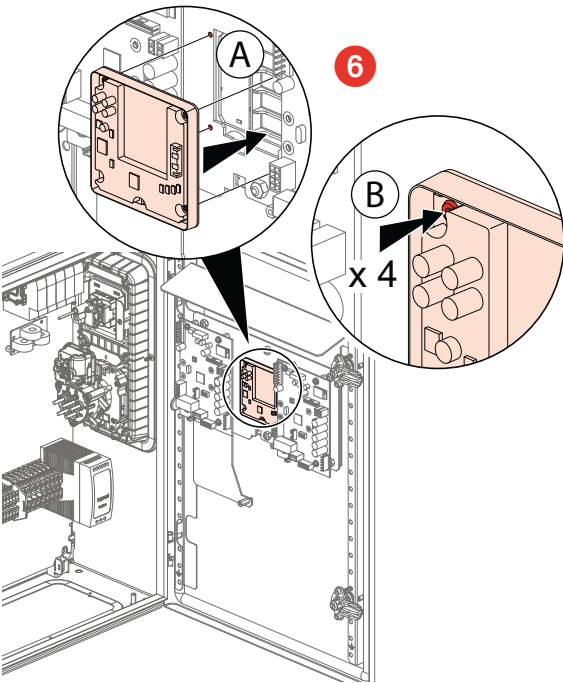
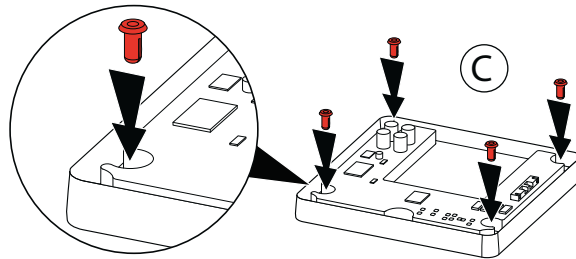
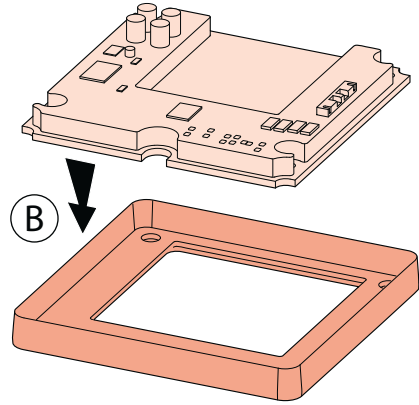
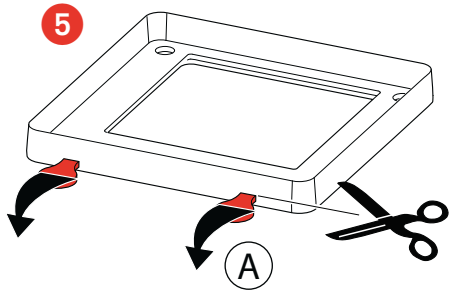

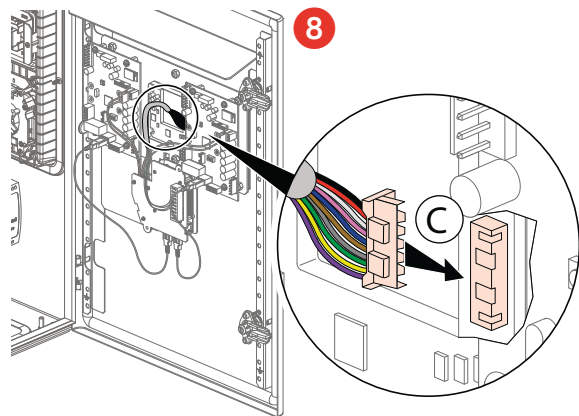

La sottoscritta società LEGRAND dichiara che l'apparecchio radioelettrico di tipo (0 590 56/59) è conforme alla Direttiva 2014/53/UE. Il testo completo della dichiarazione di conformità UE è disponibile al seguente indirizzo: [www.legrand.com](http://www.legrand.com)

Ondergetekende, LEGRAND, verklaart dat de radioapparatuur van het type (0 590 56/59) conform is met Richtlijn 2014/53/EU. De volledige tekst van de EU-conformiteitsverklaring is beschikbaar op het volgende adres: [www.legrand.com](http://www.legrand.com)

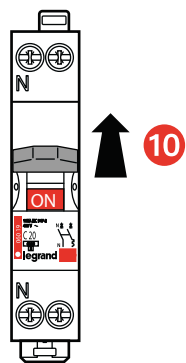
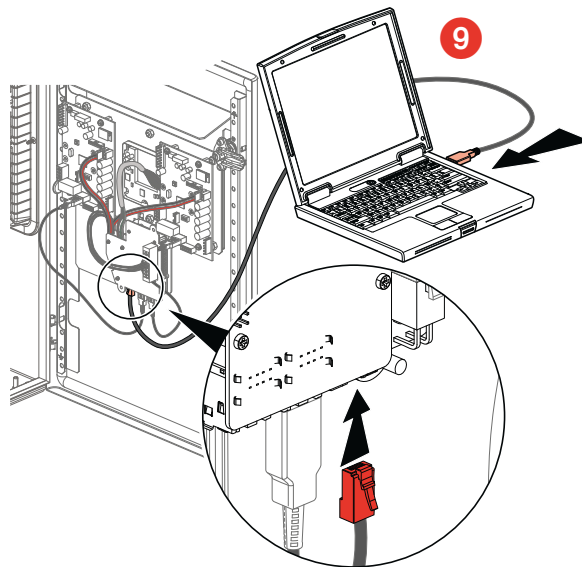

- 11** Dopo il collegamento del kit di comunicazione, si effettuerà un aggiornamento della stazione di ricarica. Dopo l'accensione, attendere circa 3 minuti prima di qualsiasi manipolazione/configurazione. Ogni lato della stazione di ricarica effettuerà automaticamente 2 riavvii durante questo processo. *Na aansluiting van de communicatiekit wordt een update van de laadpaal uitgevoerd. Na inschakeling, ongeveer 3 minuten wachten alvorens een bewerking/configuratie uit te voeren. Gedurende die tijd zal iedere zijde van de laadpaal automatisch 2 keer opnieuw opstarten.*



Inizializzazione della stazione  
*Initialisatie van de laadpaal*

Spia luminosa bianca scorrevole poi spia luminosa bianca fissa  
Aspettare il riavvio della stazione poi  
*Wit scrollen van controlelampjes, dan continu wit*  
*Wachten tot opnieuw opstarten van de laadpaal en dan*



Spia luminosa bianca fissa OK  
*Controlelampjes continu wit OK*

- 12** Configurazione, vd. pag. 72  
*Configuratie, zie blz. 72*

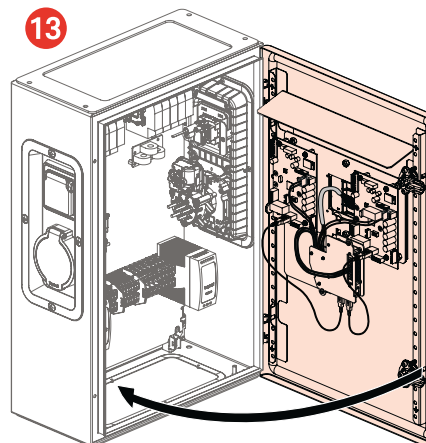



Prima di effettuare qualsiasi intervento, togliere la corrente.  
Rispettare scrupolosamente le condizioni di installazione e d'uso.  
Vóór iedere ingreep de stroom uitschakelen.  
De installatie- en gebruiksvoorwaarden nauwgezet in acht nemen.

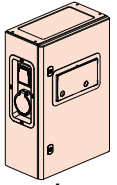

+  
0 590 56

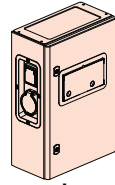
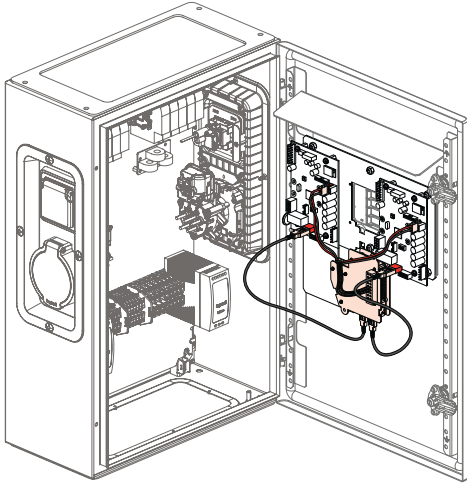

+  
0 590 56  
+  
0 590 59 **II**

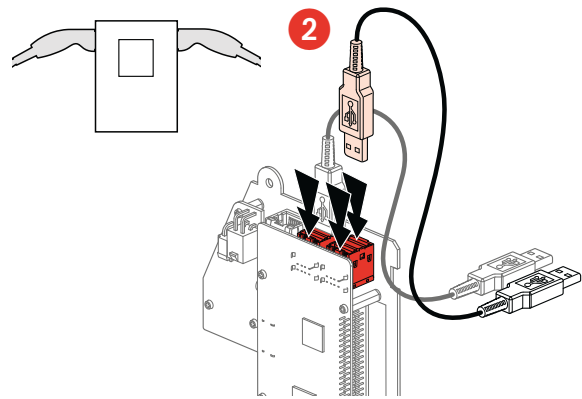
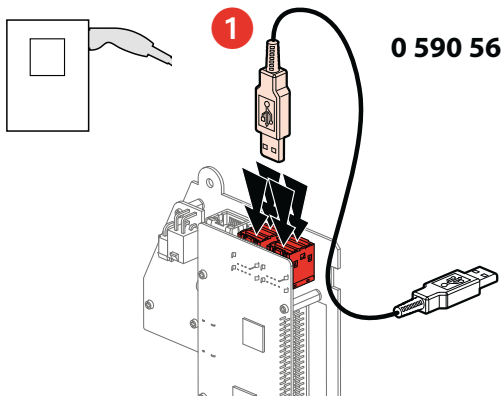
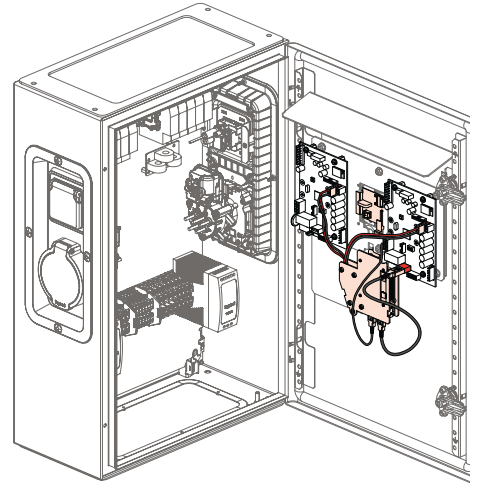

**3** 0 590 56 + 0 590 59 **II**

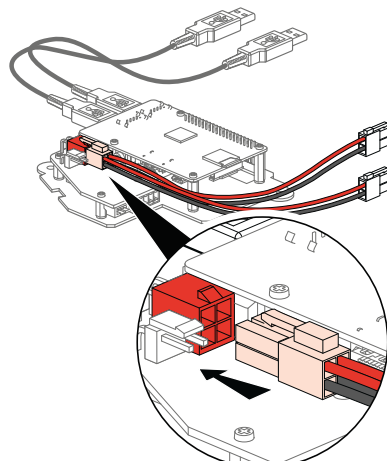

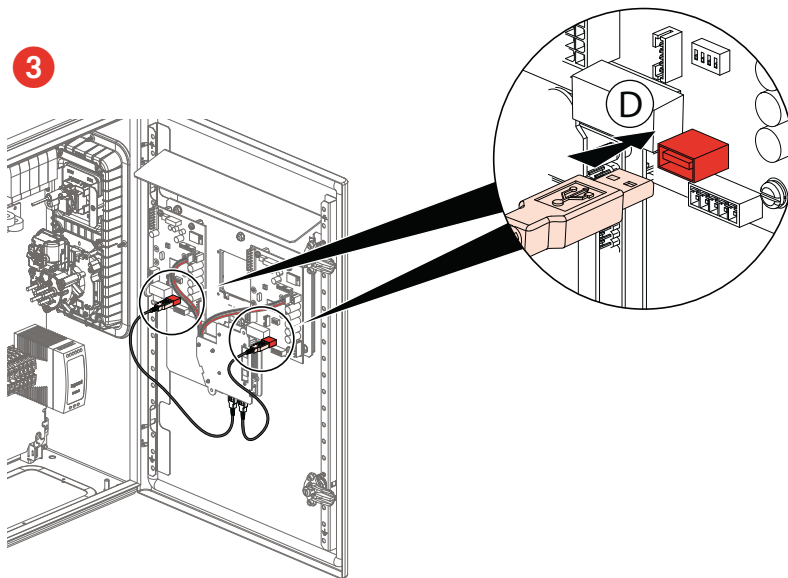
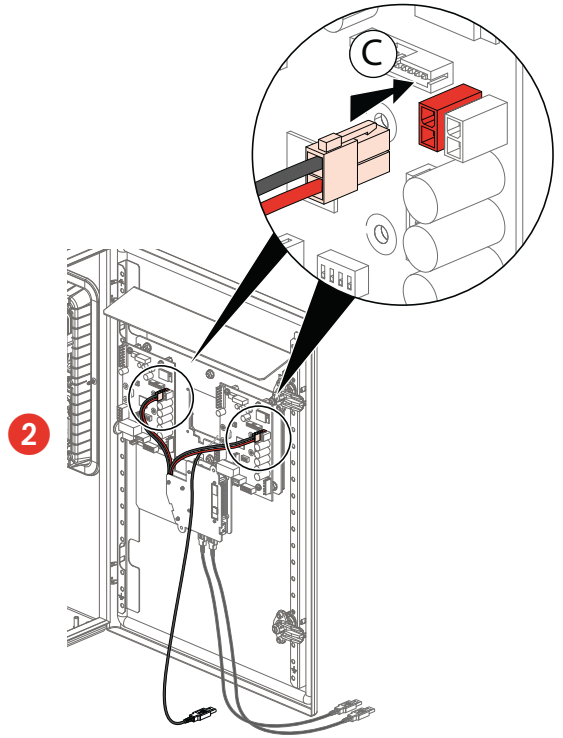
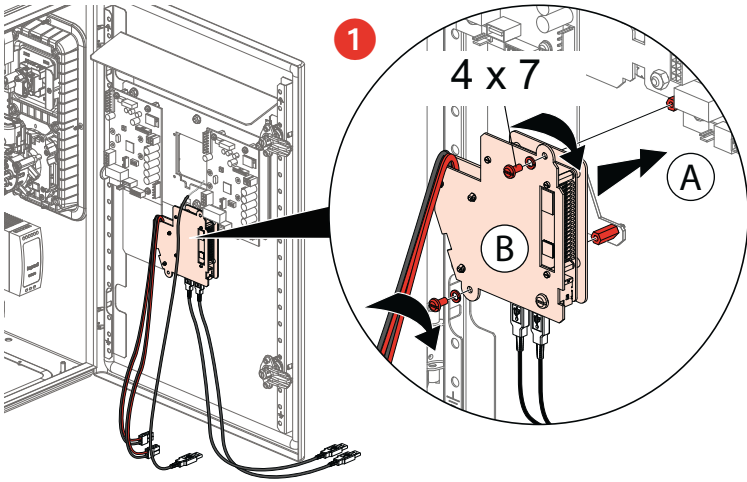



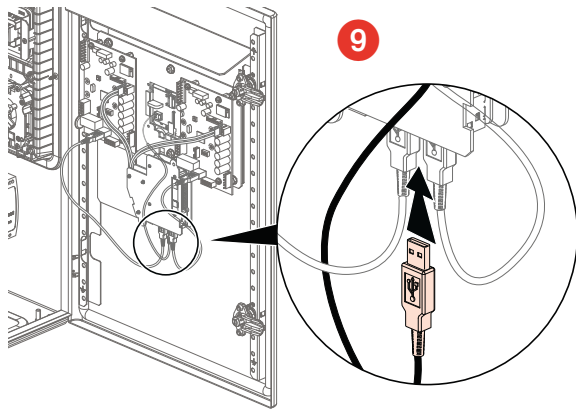
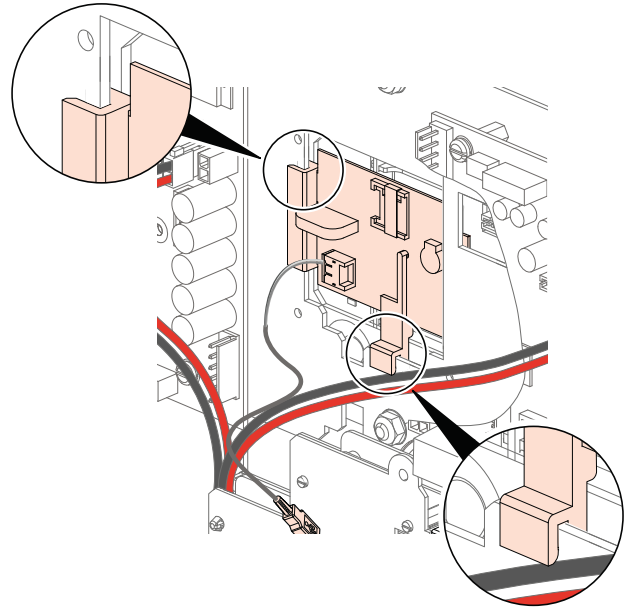
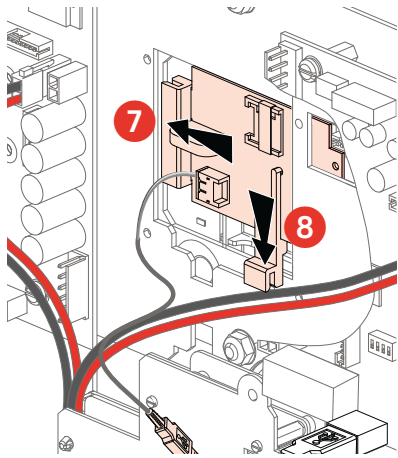
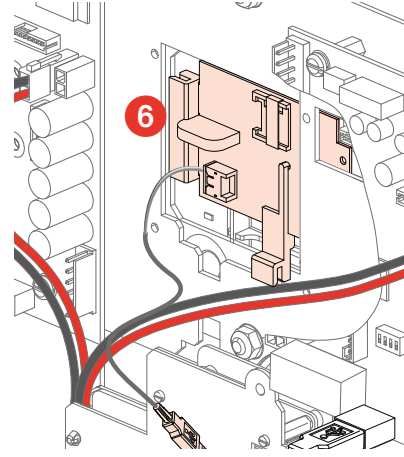
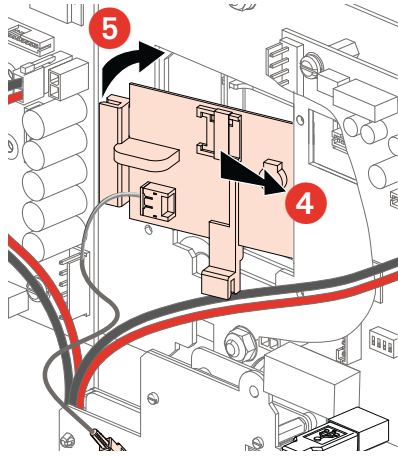

La sottoscritta società LEGRAND dichiara che l'apparecchio radioelettrico di tipo (0 590 56/59) è conforme alla Direttiva 2014/53/UE. Il testo completo della dichiarazione di conformità UE è disponibile al seguente indirizzo: [www.legrand.com](http://www.legrand.com)

Ondergetekende, LEGRAND, verklaart dat de radioapparatuur van het type (0 590 56/59) conform is met Richtlijn 2014/53/EU. De volledige tekst van de EU-conformiteitsverklaring is beschikbaar op het volgende adres: [www.legrand.com](http://www.legrand.com)

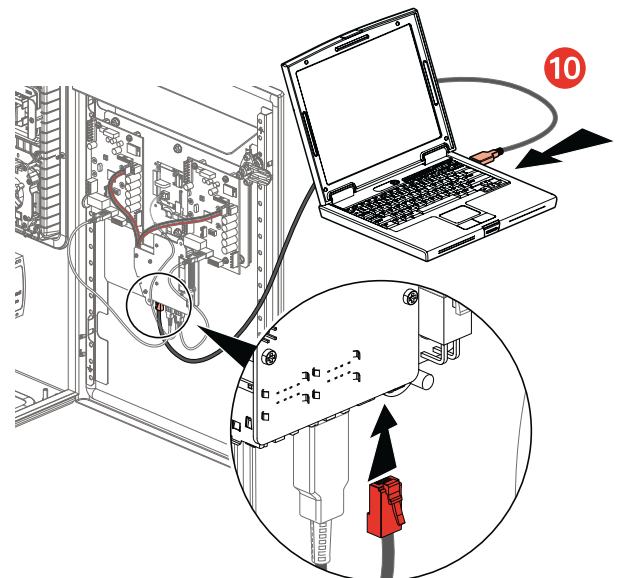

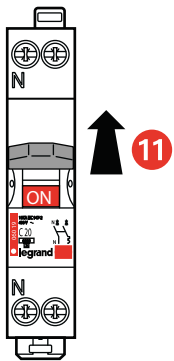

**12**

Dopo il collegamento del kit di comunicazione, si effettuerà un aggiornamento della stazione di ricarica. Dopo l'accensione, attendere circa 3 minuti prima di qualsiasi manipolazione/configurazione. Ogni lato della stazione di ricarica effettuerà automaticamente 2 riavvii durante questo processo.  
*Na aansluiting van de communicatiekit wordt een update van de laadpaal uitgevoerd.*  
*Na inschakeling, ongeveer 3 minuten wachten alvorens een bewerking/configuratie uit te voeren.*  
*Gedurende die tijd zal iedere zijde van de laadpaal automatisch 2 keer opnieuw opstarten.*



Inizializzazione della stazione  
*Initialisatie van de laadpaal*

Spia luminosa bianca scorrevole poi spia luminosa bianca fissa  
Aspettare il riavvio della stazione poi  
*Wit scrollen van controlelampjes, dan continu wit*  
*Wachten tot opnieuw opstarten van de laadpaal en dan*



Spia luminosa bianca fissa OK  
*Controlelampjes continu wit OK*

**13**

Configurazione, vd. pag. 72  
*Configuratie, zie blz. 72*

**14**

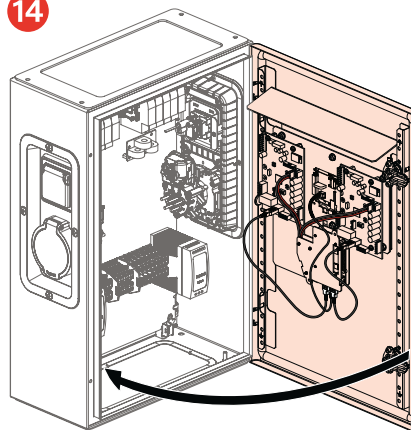



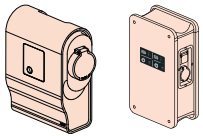
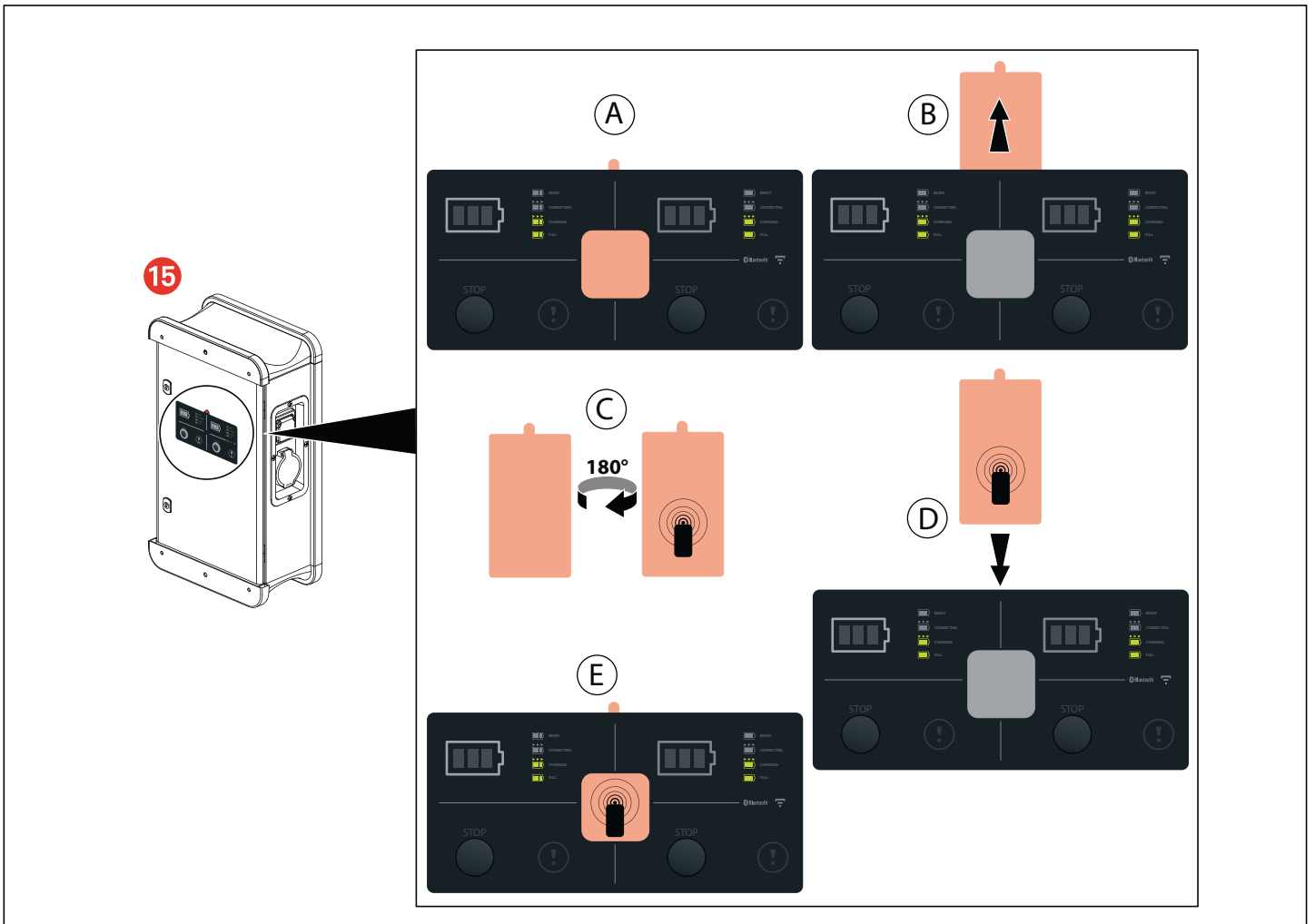

**COLLEGAMENTO/AANSLUITING 0 590 56/59**

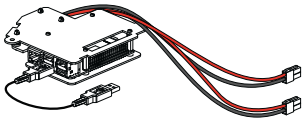
<b>cod. / ref.</b>	<b>Gestione - Pagine - Web Beheer - Pagina's - Web</b>	<b>Applicazione EV charge Applicatie EV charge</b>	<b>Modbus</b>	<b>OCPP</b>
<b>0 590 56</b>  	<b>RJ 45</b> <b>o/of</b> <b>WIFI</b>	<b>RJ 45</b> <b>o/of</b> <b>WIFI</b>	<b>RS 485</b>	<b>RJ 45</b>

## SCHEMA DI COLLEGAMENTO RJ 45/AANSLUITSCHEMA RJ 45

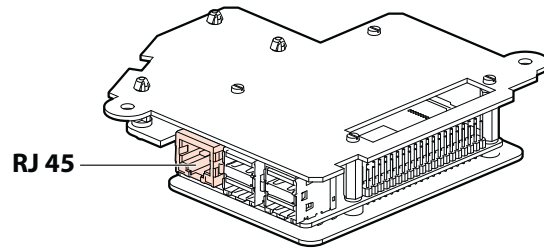

## SCHEMA DI COLLEGAMENTO RS485/AANSLUITSCHEMA RS485

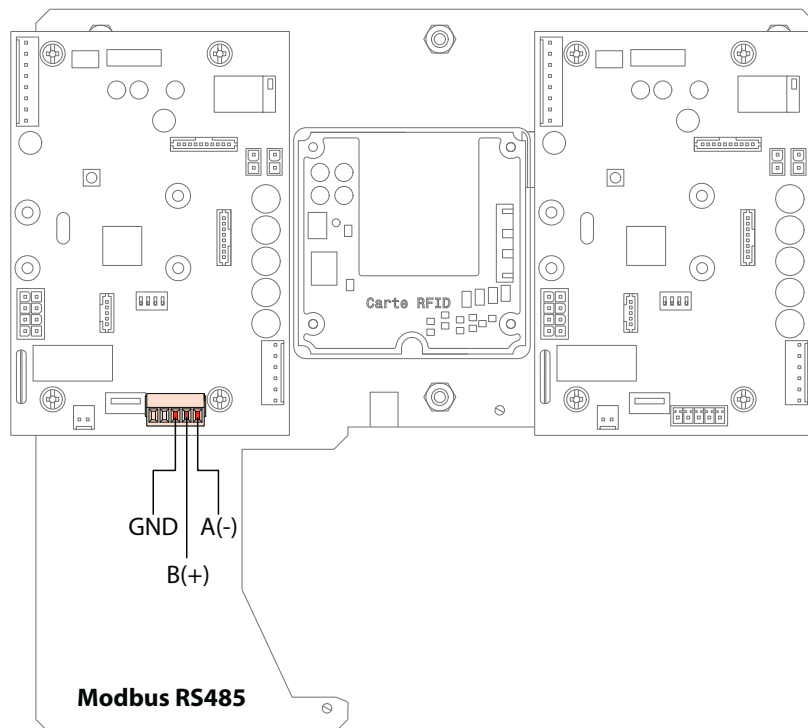

## CONFIGURAZIONE ACCESSO PAGINE WEB

Per configurazione IP, Modbus, RFID

- 1) Collegare il PC in LAN al kit Com tramite il cavo RJ 45
- 2) Configurare una rete locale
  - a) Al centro rete e condivisione ((cliccare sul pulsante Avvio (logo vedere istruzioni LE08734AA-00) digitare «centro rete e condivisione» nella barra di ricerca.))
  - b) Cliccare su connessione alla rete locale
  - c) Cliccare su proprietà
  - d) Cliccare su protocollo Internet versione 4 (TCP/IP v4)
  - e) Cliccare su proprietà
  - f) Cliccare su utilizza il seguente indirizzo IP:  
**adresse IP 192.168.1.199**  
**subnet mask 255.255.255.0**  
**gateway predefinito 192.168.1.1**  
immettere i valori per indirizzo, mask e gateway
  - g) Cliccare su OK
  - h) Aprire il browser e digitare l'indirizzo IP **192.168.1.200**

- 3) Schermo modulo di connessione
  - a) Prima connessione (login e password predefiniti)  
**Login: admin**  
**Password: admin**
  - 4) Per ragioni di sicurezza, bisogna cambiare la password  
Login:  
Password:

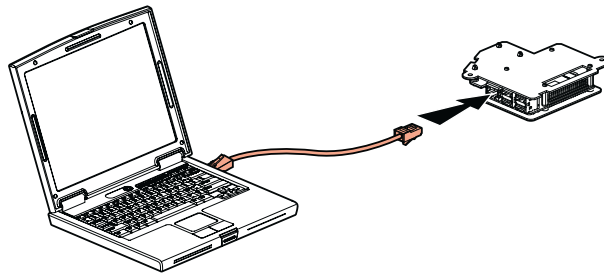

## CONFIGURATIE VAN TOEGANG TOT WEB-PAGINA'S

Voor configuratie van IP, Modbus, RFID

- 1) De pc in LAN-configuratie verbinden met de Com-kit via het snoer RJ 45
- 2) Een lokaal netwerk instellen
  - a) In Netwerkcentrum ((klikken op de Start-knop (logo zie handleiding LE08734AA-00) "Netwerkcentrum" intypen in de zoekbalk.))
  - b) Klikken op verbinding met het lokale netwerk
  - c) Klikken op eigenschappen
  - d) Klikken op internetprotocol versie 4 (TCP/IP v4)
  - e) Klikken op eigenschappen
  - f) Klikken op "Het volgende IP-adres gebruiken":  
**IP-adres 192.168.1.199**  
**Subnetmasker 255.255.255.0**  
**Standaard-gateway 192.168.1.1**  
De waarden voor adres, masker en gateway invullen
  - g) Klikken op OK
  - h) De browser openen en het IP-adres **192.168.1.200** intypen

- 3) Scherm verbindingsformulier
  - a) Eerste verbinding (Standaardlog-in en wachtwoord)  
**Login : admin**  
**Wachtwoord: admin**
  - 4) Verander uw wachtwoord om beveiligingsredenen  
Log-in:  
Wachtwoord:

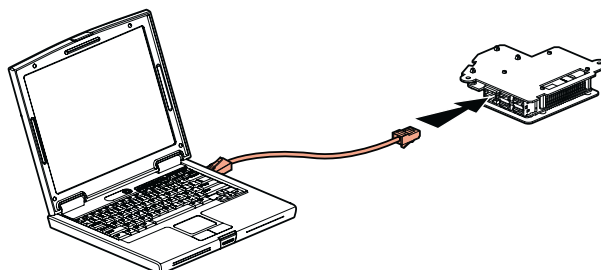

## Schermata iniziale



## Startschirm



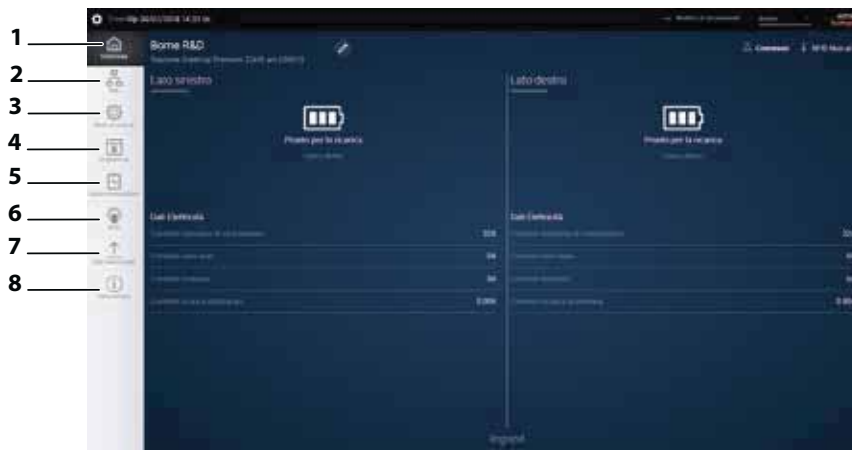

**LEGENDA:**

**1- Pannello di controllo**

Permette di visualizzare lo stato di funzionamento della stazione per ogni lato

**2- Rete**

Permette di configurare una rete cablata e/o wireless (Wifi)

**3- Modalità di carica**

Permette di scegliere la modalità di carica della stazione per ogni lato

**4- Programmi**

ermette di gestire la programmazione oraria della stazione per ogni lato

**5- Azioni di impostazione**

ermette di effettuare azioni sulla stazione da remoto (intensità, blocco, interruzione della carica ...)

**6- RFID**

Permette:

- l'attivazione dell'RFID (con cod. 0 590 59)
- la gestione dei badge
- la gestione della modalità di funzionamento locale o da remoto

**7- Cronologia**

Permette di scaricare le cronologie di ricarica e degli errori della stazione per lato

**8- Informazioni/aggiornamenti**

Permette la visualizzazione delle informazioni sul sistema della stazione (versione software e hardware)



**Prima della prima messa in funzione, scaricare il manuale d'uso e installare l'ultimo aggiornamento del kit di comunicazione su [www.legrand.com](http://www.legrand.com)**

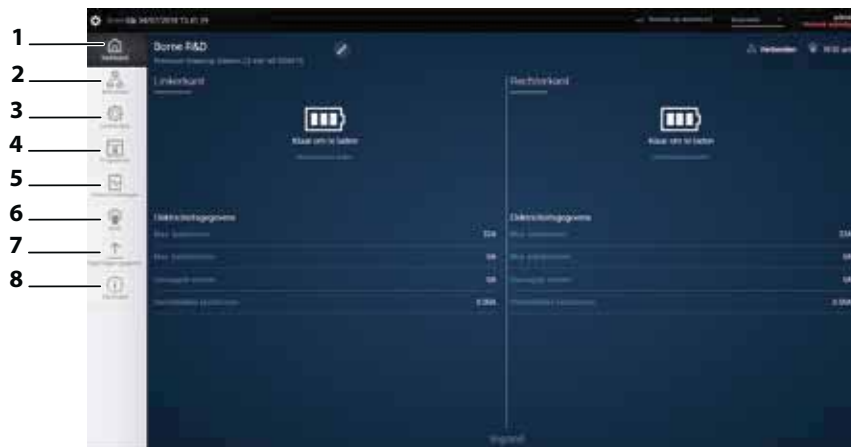

**LEGENDE:**

**1- Bedieningspaneel**

Verschaft een weergave van de werkingstoestand van de laadpaal per zijde

**2- Netwerk**

Geeft u de mogelijkheid om een kabelnetwerk of een draadloos netwerk (Wifi) in te stellen

**3- Oplaadmodus**

Hiermee kan de oplaadmodus van de laadpaal per zijde worden gekozen

**4- Programma's**

Maakt het mogelijk om de tijdsintervallen van de laadpaal per zijde te programmeren

**5- Acties Instellingen**

Stelt u in staat om op afstand acties uit te voeren op de laadpaal (helderheid, vergrendeling, stoppen met laden ...)

**6- RFID**

Bestemd voor:

- activering van RFID (met ref. 0 590 59)
- beheer van de kaarten
- beheer van de werkingsmodus: lokaal of op afstand

**7- Overzicht**

Hiermee krijgt u een historisch overzicht van de laadcycli en de storingen van de laadpaal per zijde

**8- Inlichtingen/updates**

Geeft een weergave van de systeeminlichtingen van de laadpaal (software- en hardwareversie)



**Vóór iedere eerste inbedrijfstelling de gebruikershandleiding downloaden en de meest recente update op uw communicatiekit installeren vanaf [www.legrand.com](http://www.legrand.com)**

### 1. Registrazione locale dei badge sulla stazione:

Collegarsi al kit di comunicazione:

Aprire la scheda RFID

Attivare il lettore RFID

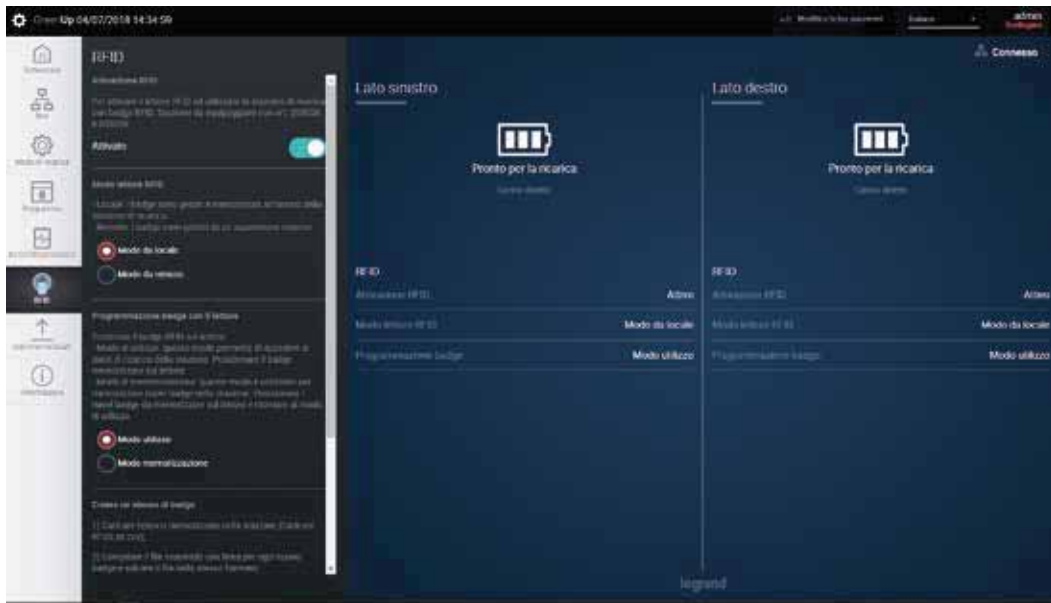

Selezionare "Modo da locale"

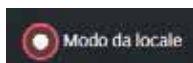

### 1. De kaarten lokaal registreren op de laadpaal:

Verbinding maken met de communicatiekit:

Het tabblad RFID openen

De RFID-lezer activeren

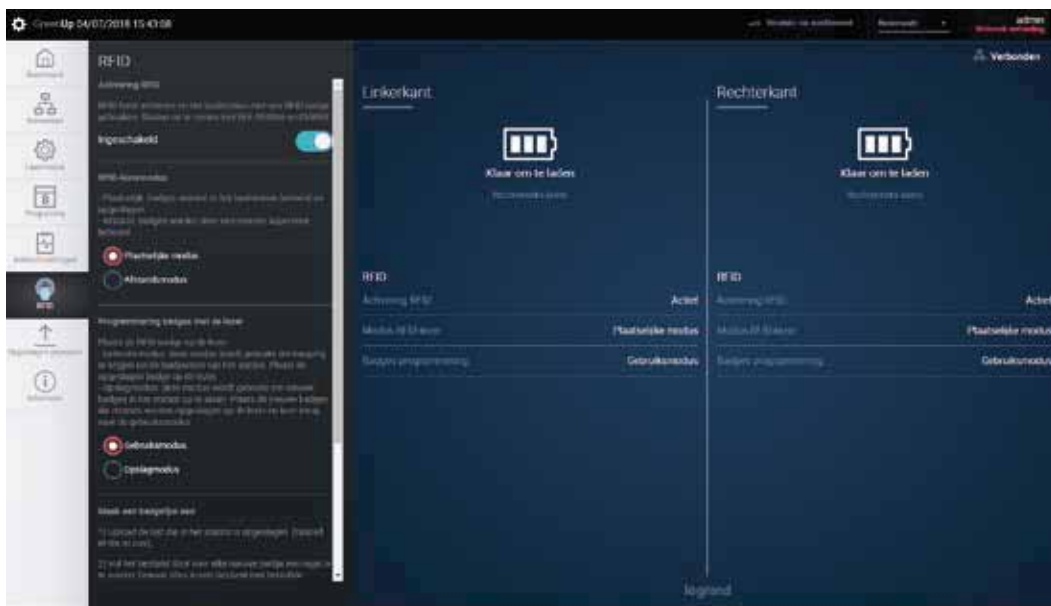

De "Plaatselijke modus" selecteren

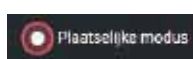

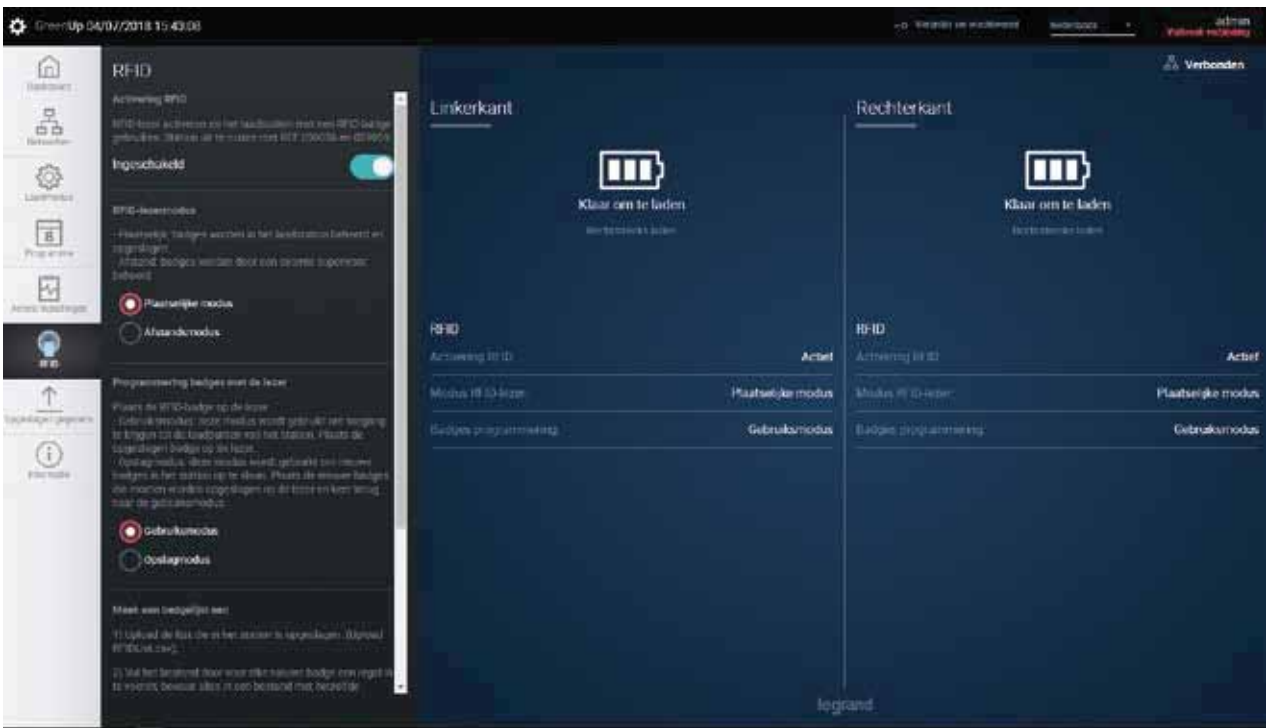
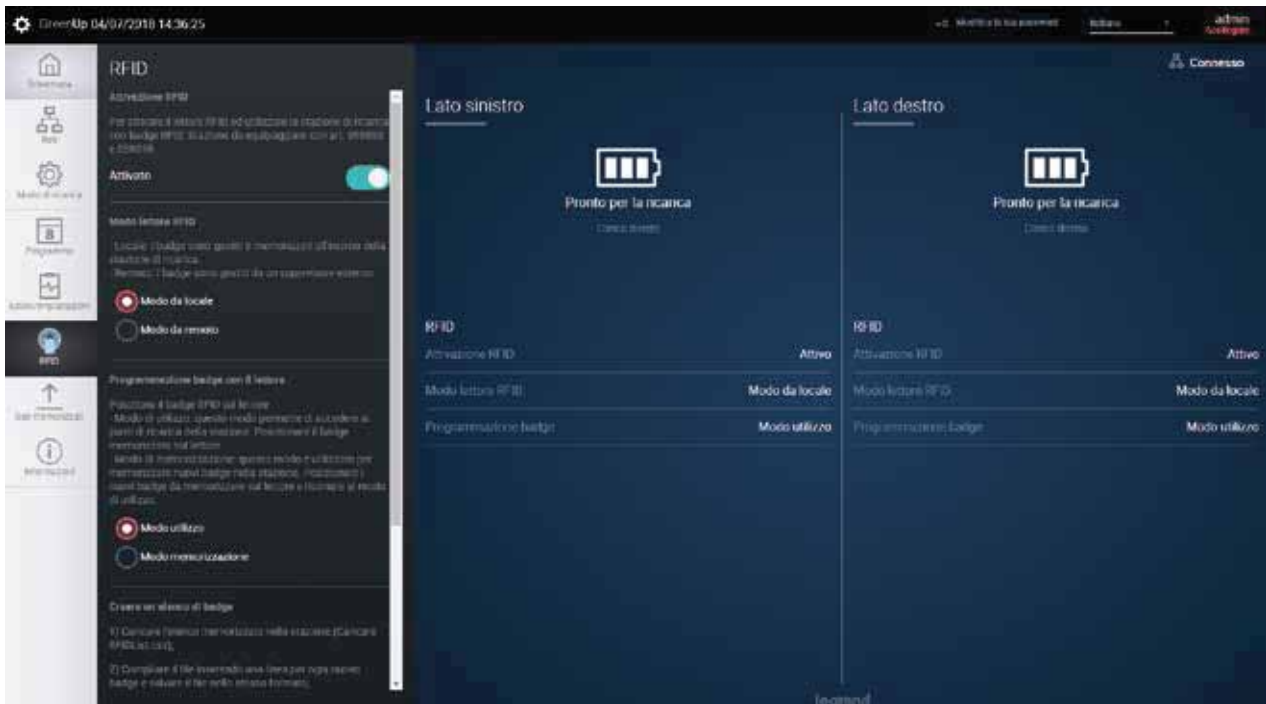



## Selezionare "Modo da remoto"

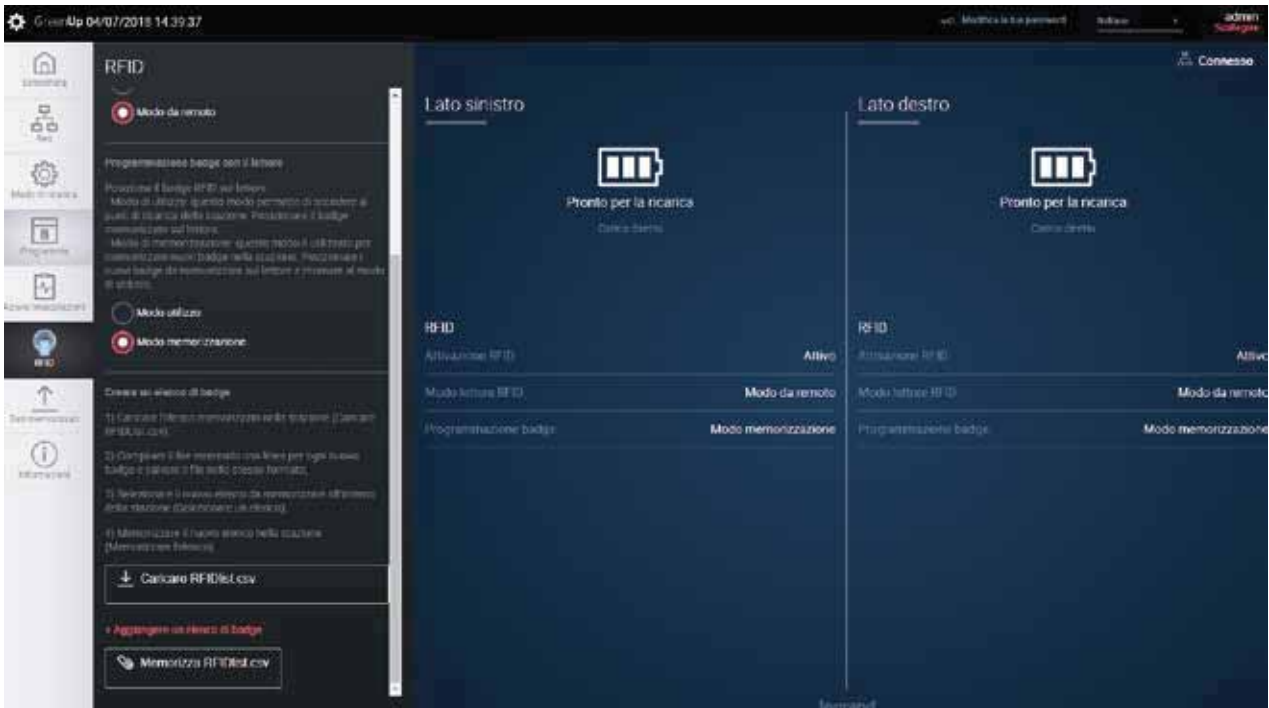
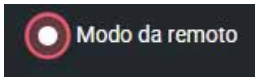

## De "Afstandsmodus" selecteren



Poi andare davanti alla stazione: Spie luminose bianche scorrevoli sull'interfaccia  
 ⇒ La stazione è pronta a registrare i badge  
 Passare il badge da registrare davanti al lettore RFID: spie luminose verdi scorrevoli  
 ⇒ Il badge è registrato  
 Ripetere l'operazione per tutti i badge de registrare  
 Alla conclusione della registrazione dei badge, tornare alla modalità utilizzo

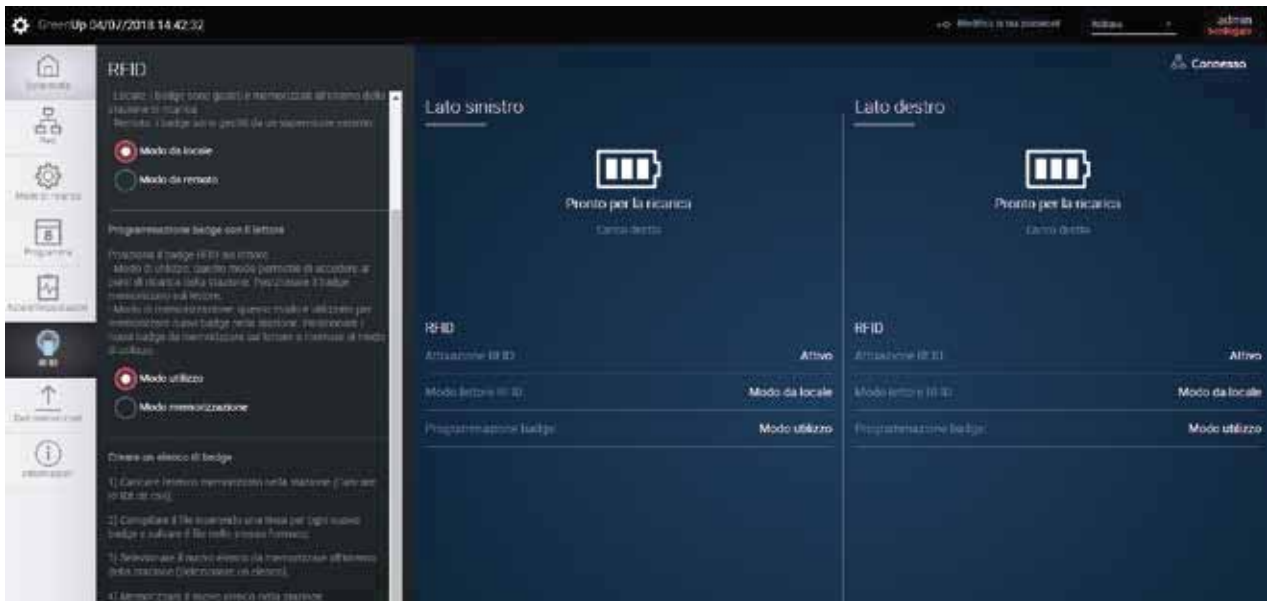

**Osservazione:** se si passa davanti alla stazione un badge già registrato, una spia luminosa rossa lampeggia

Vervolgens voor de laadpaal gaan staan: Wit scrollen van controlelampjes op de interface  
 ⇒ De laadpaal is klaar om de kaarten te registreren  
 De te registreren kaart voor de RFID-lezer houden: Groen scrollen van de controlelampjes  
 ⇒ De kaart is geregistreerd.  
 De bewerking herhalen voor alle overige te registreren kaarten  
 Wanneer de kaarten geregistreerd zijn, overgaan op de gebruiksmodus



**Opmerking:** Als een kaart voor de laadpaal wordt gehouden die al geregistreerd is, gaat een rood licht knipperen

## 2. Creazione e utilizzo di un elenco di badge

Collegarsi al kit di comunicazione:

Aprire la scheda RFID

Attivare il lettore RFID

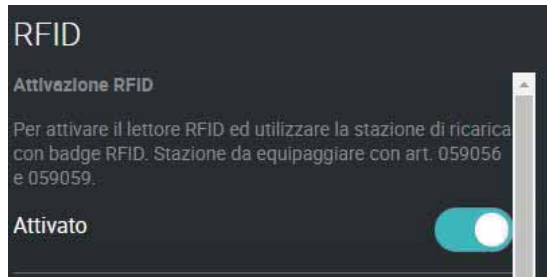

Selezionare "Modo da locale"

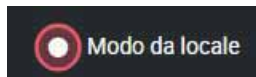

Selezionare "Modo da remoto"

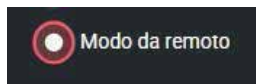

## 2. Een lijst van kaarten aanmaken en gebruiken

Verbinding maken met de communicatiekit:

Het tabblad RFID openen

De RFID-lezer activeren



De "Plaatselijke modus" selecteren



De "Opslagmodus" selecteren

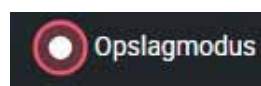

Esempio di elenco di badge:

Rispettare assolutamente il formato qui sotto  
(date e nomi facoltativi):

Date	Id	Name
26/02/2018 08:40	2000236672	Dupont
26/02/2018 08:39	2000243520	Durand
26/02/2018 08:39	1997833664	Martin

End

a) Creazione di un elenco di badge:

- creare un file RFIDList.csv secondo le condizioni indicate qui sopra
- completare con i dati dei badge ed eventualmente i nomi e le date corrispondenti
- Cliccare su "+ Aggiungere un elenco di badge" per selezionarlo

+ Aggiungere un elenco di badge Nessun file scelto

- Cliccare su "Memorizza RFIDList.csv"

 Memorizza RFIDlist.csv

⇒ L'elenco di badge è salvato

b) Modifica di un elenco di badge:

- Cliccare su "Caricare RFIDList.csv"

 Caricare RFIDlist.csv

c) Esportazione di un elenco di badge

- Cliccare su "Memorizza RFIDList.csv"

 Memorizza RFIDlist.csv

- Effettuare le modifiche nel file (aggiunte, eliminazioni, cambio utente)

- Salvare le modifiche

- Cliccare su "Scegli un file" per selezionarlo

- Cliccare su "Memorizza RFIDList.csv"

 Memorizza RFIDlist.csv

⇒ Il nuovo elenco di badge è salvato

Voorbeeld van een lijst van kaarten:

Het formaat hieronder strikt in acht nemen

(datums en namen zijn facultatief):

Date	Id	Name
26/02/2018 08:40	2000236672	Dupont
26/02/2018 08:39	2000243520	Durand
26/02/2018 08:39	1997833664	Martin

End

a) Een lijst van kaarten aanmaken:

- een bestand *RFIDList.csv* aanmaken volgens de voorwaarden hierboven
- de gegevens van de kaarten invullen en eventueel aanvullen met overeenkomstige namen en datums
- klikken op "+ Voeg een badgelijst toe" om het te selecteren

+ Voeg een badgelijst toe    Geen bestand gekozen

- klikken op "*Sla RFIDList.csv op*"

 Sla RFIDlist.csv op

⇒ Uw lijst van kaarten is opgeslagen

b) Een lijst van kaarten bewerken:

- klikken op "*Upload RFIDList.csv*"

 Upload RFIDlist.csv

c) Een lijst van kaarten exporteren

- klikken op "*Sla RFIDList.csv op*"

 Sla RFIDlist.csv op

- uw wijzigingen aanbrengen in het bestand (aanvullingen, schrappingen, wijzigingen van gebruikers)

- de wijzigingen opslaan

- klikken op "een bestand kiezen" om het te selecteren

- klikken op "*Sla RFIDList.csv op*"

 Sla RFIDlist.csv op

⇒ Uw nieuwe lijst van kaarten is opgeslagen

### 3.Utilizzo del lettore di badge con una gestione centralizzata

Collegarsi al kit di comunicazione:

Aprire la scheda RFID

Attivare il lettore RFID

Selezionare "Modo da remoto"  
(utilizzo del protocollo di comunicazione Wiegand)

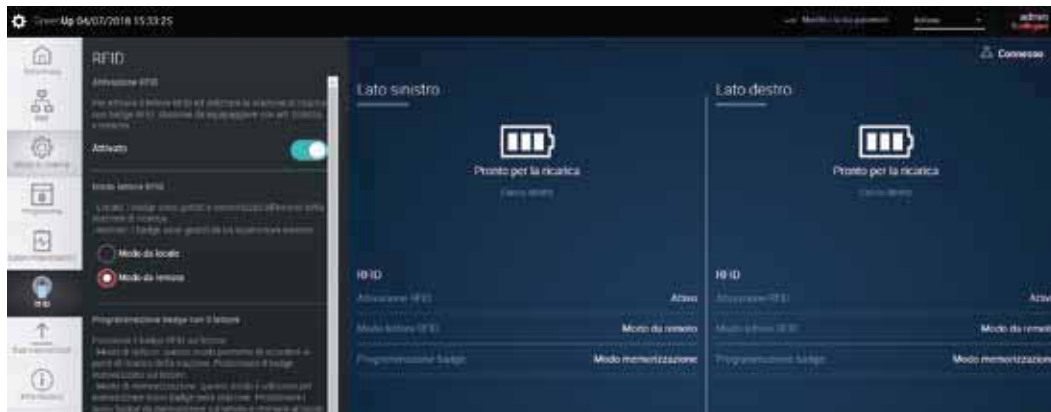
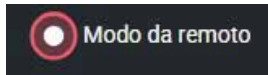

### 3. Gebruik van de kaartlezer met gecentraliseerd beheer

Verbinding maken met de communicatiekit:

Het tabblad RFID openen

De RFID-lezer activeren

De "Afstandsmodus" selecteren  
(gebruik van het communicatieprotocol Wiegand)

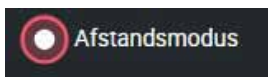

#### 4.Utilizzo della stazione con badge RFID

Attivare il lettore RFID

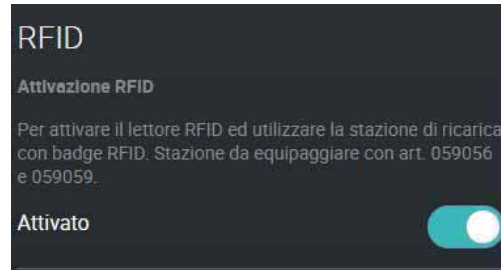

Sulla scheda RFID, passare in modalità utilizzo

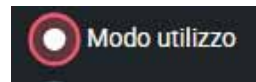

Seguire questo ordine di operazioni

- a) Collegare il cavo sulla stazione  
Passare il badge davanti alla stazione  
Le spie luminose bianche lampeggiano dal lato del cavo => inizia la ricarica
- b) Passare il badge davanti alla stazione:  
le spie luminose verdi lampeggiano  
Collegare il cavo (durata massima:  
1 minuto, oltre un minuto, ripassare il badge davanti alla stazione)

5. Inizia la ricarica

##### **Badge non registrato:**

Se si passa un badge non registrato davanti alla stazione:  
lampeggiano delle spie luminose rosse

#### 4. Gebruik van de laadpaal met RFID-kaarten

*De RFID-lezer activeren*



*In het tabblad RFID, overgaan naar de gebruiksmodus*

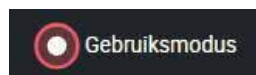

*Naar gelang van de volgorde van de bewerkingen*

- a) *Het snoer aansluiten op de laadpaal*  
*De kaart voor de laadpaal houden*  
*De witte controlelampjes knipperen aan de zijde van het snoer => het laden gaat van start*
- b) *De kaart voor de laadpaal houden:*  
*de groene controlelampjes knipperen*  
*Het snoer aansluiten (binnen maximaal:*  
*1 minuut. Als één minuut verstreken is, de kaart opnieuw voor de laadpaal houden)*

5. Het laden start

##### **Niet geregistreerde kaart:**

*Indien een niet geregistreerde kaart voor de laadpaal wordt gehouden:*  
*rood "flikkeren" van de controlelampjes*





Scaricabile su  
*Te downloaden van*  
[www.legrand.com](http://www.legrand.com)  
LE10817AA-01 (FR)  
LE10990AA-01 (EN)

STAZIONI DI RICARICA GREEN'UP PREMIUM  
*GREEN'UP PREMIUM CHARGING STATIONS*

**Manuale d'uso**  
***Gebruikershandleiding***  
Kit di comunicazione & lettore RFID  
*Communicatiekit en RFID-lezer*



**Sicherheitshinweise**

WEEE



Konfiguration des Zugriffs auf Webseiten ..... S. 100

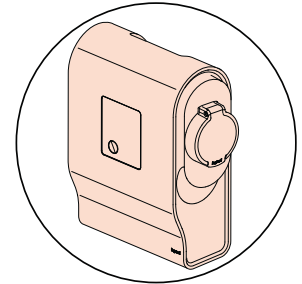

Installation  
0 590 56 ..... S. 86

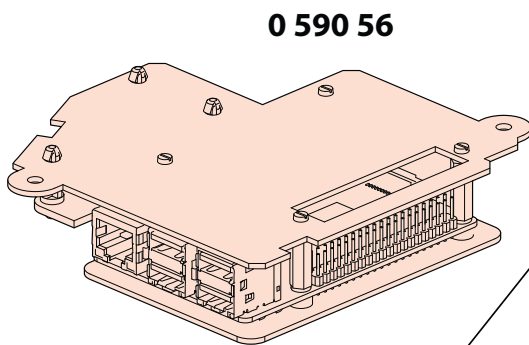

**0 590 56**

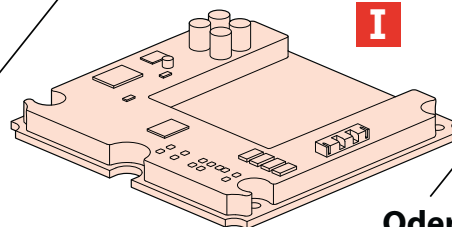

**0 590 59**

Oder

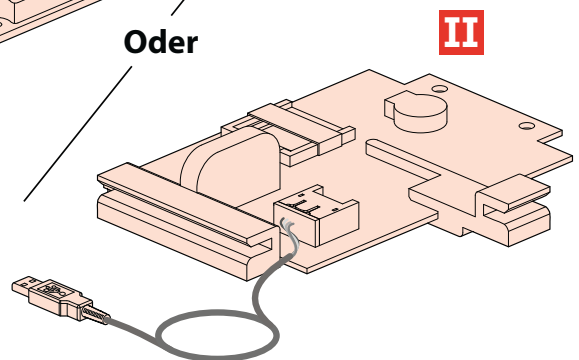

**II**

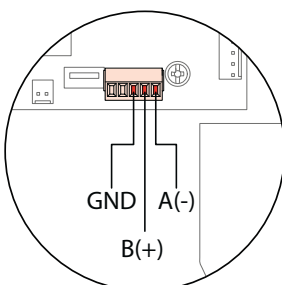

Anschließen der Steckverbinder ..... S. 98



Installation  
0 590 56 oder  
0 590 56 + 0 590 59 ..... S. 90

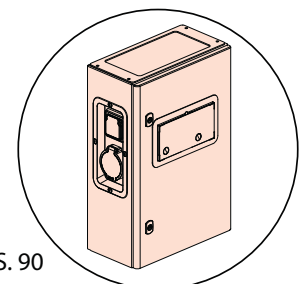

0 590 56

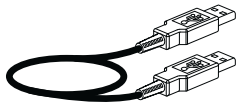
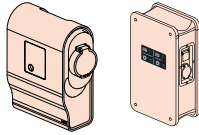

x 2

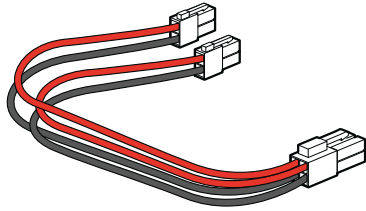
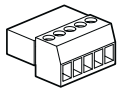
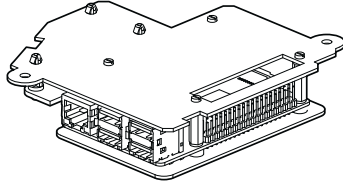

M4 x 7  
x 2

4 x 12  
x 2

0 590 59

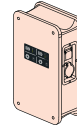

**I**

Oder

**II**



x 4

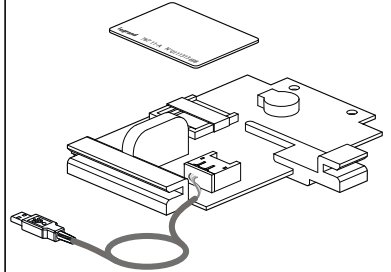
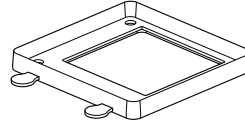
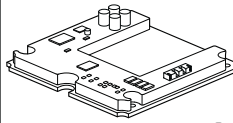
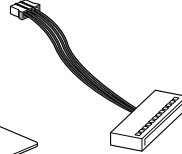

**Stellen Sie vor der Inbetriebnahme sicher, dass die Stromversorgung unterbrochen ist.  
Halten Sie sich strikt an die Gebrauchs- und Installationsanweisungen.**

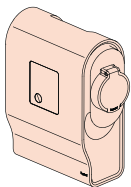

+ 0 590 56

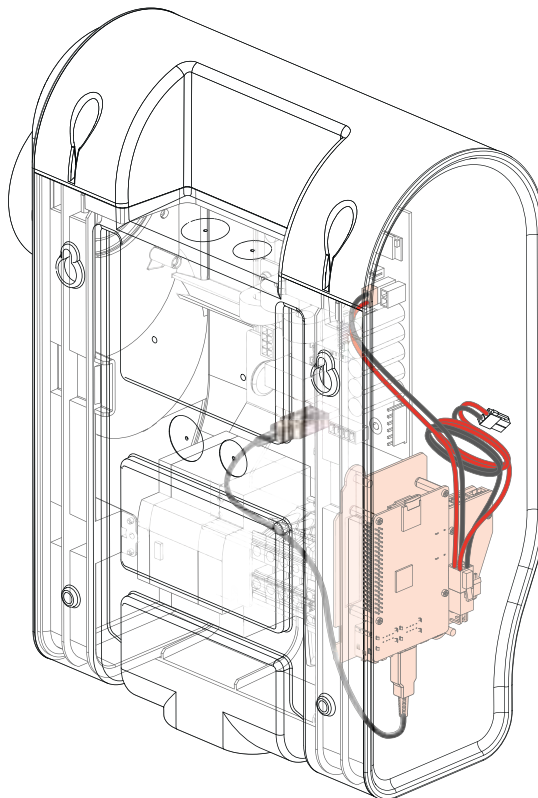

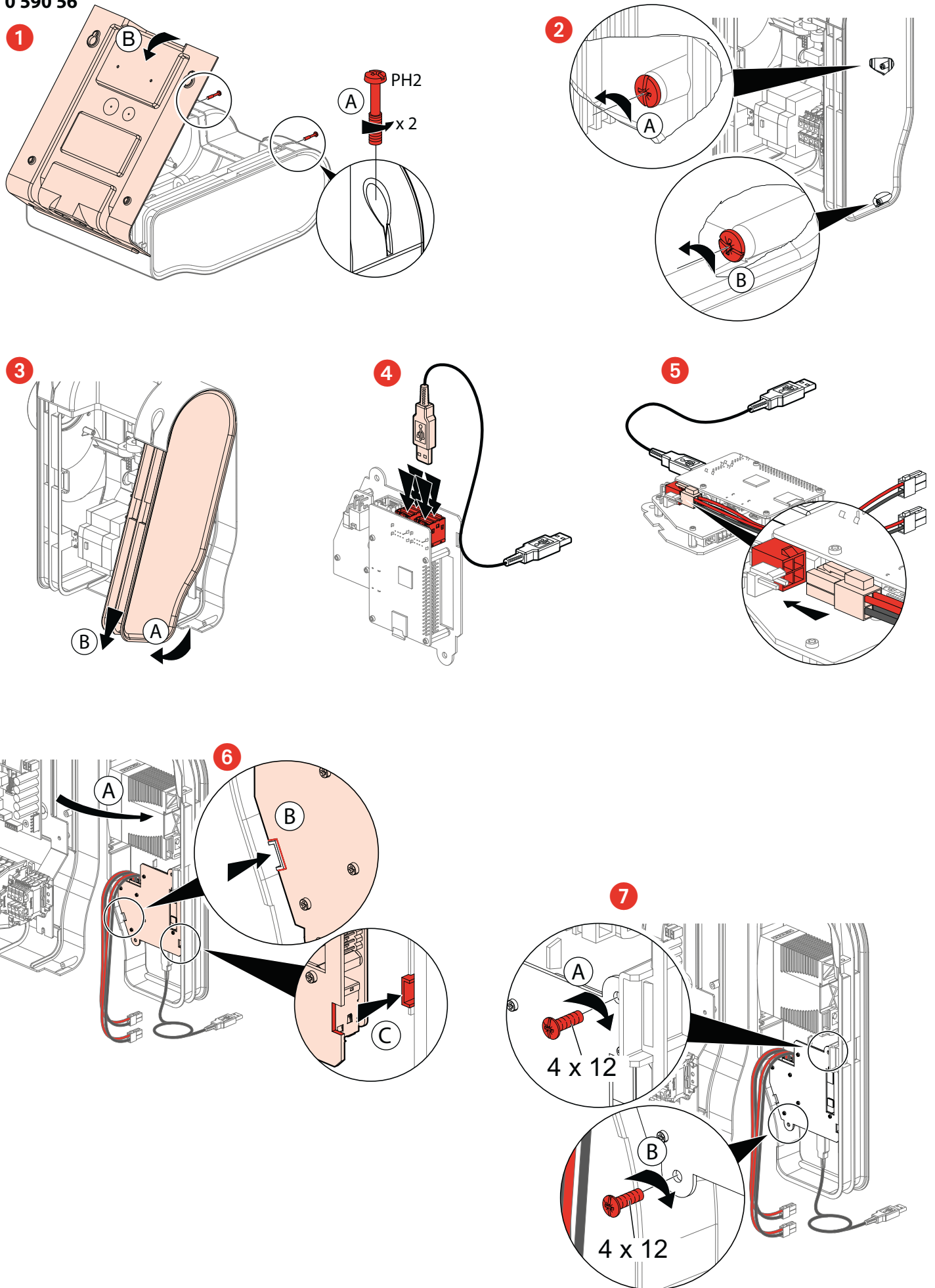

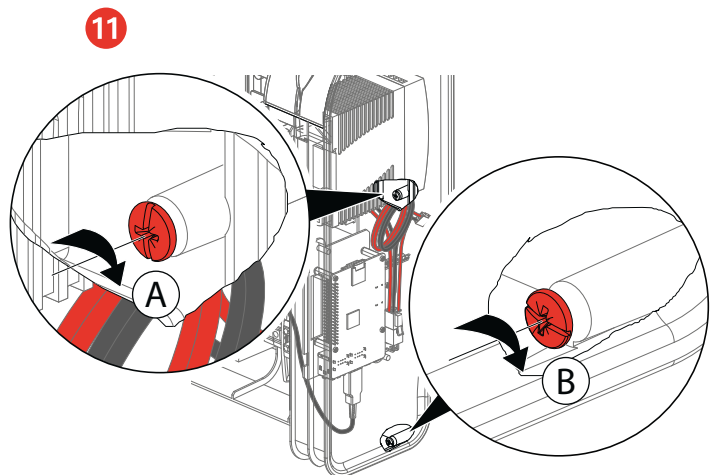
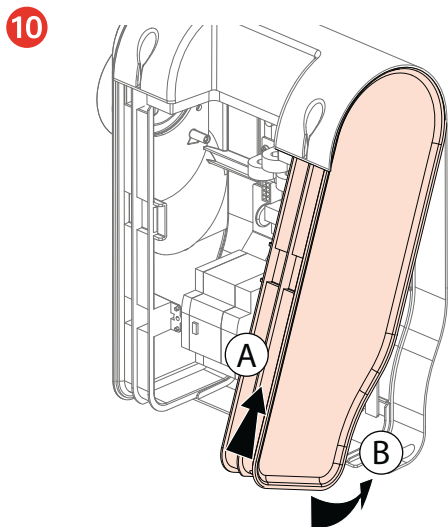
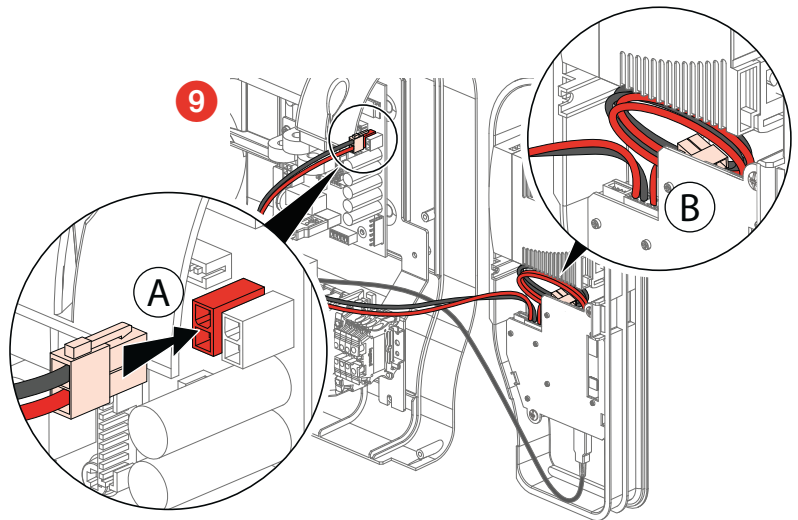
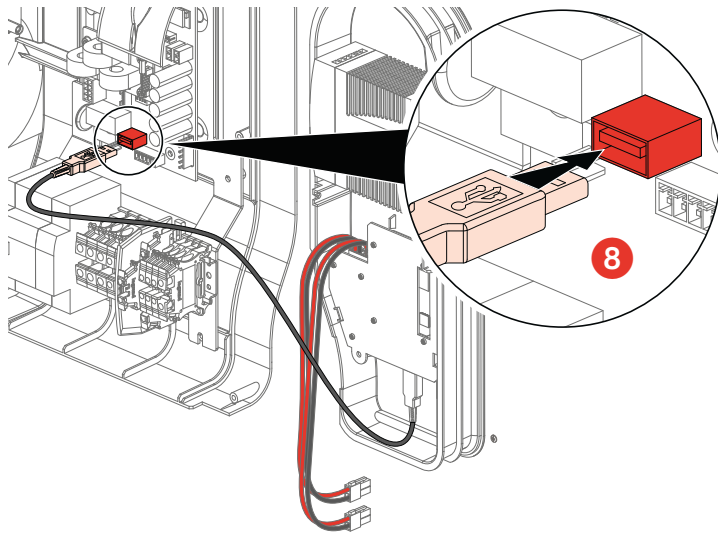

Der Unterzeichnete, LEGRAND, erklärt, dass die Funkanlage des Typs (0 590 56/59) den Anforderungen der Richtlinie 2014/53/EU entspricht. Den vollständigen Text der EU-Konformitätserklärung finden Sie auf: [www.legrand.com](http://www.legrand.com)

12

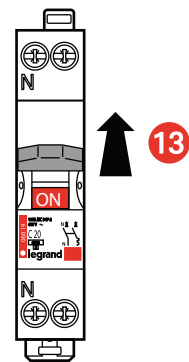
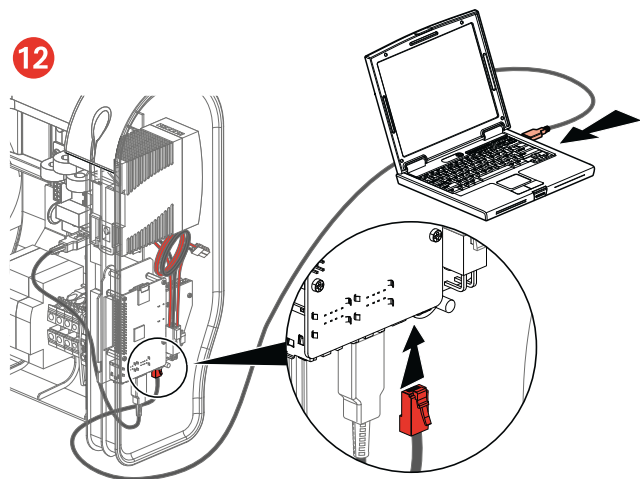

14

Ihre Ladestation wird sich selbst updaten, sobald das Kommunikationskit verbunden wurde. Warten Sie beim Einschalten mindestens 3 Minuten, bevor Sie die Station konfigurieren oder andere Vorgänge ausführen. In diesem Zeitraum wird jede Seite Ihrer Ladestation automatisch zweimal neu gestartet.



Initialisieren der Ladestation

Weißes Lauflicht und dann konstant weiß leuchtende LEDs  
Warten Sie, dass die Ladestation neu startet und dann

**Hinweis: Konfiguration siehe Seite 100**



Konstant weiß leuchtende Anzeige – OK

15

Kabeleingang für die Kabelverbindung (RJ45);  
weitere Informationen auf Seite 3 der Gebrauchsanweisung  
Nr. LE09745AA Ihrer Ladestation

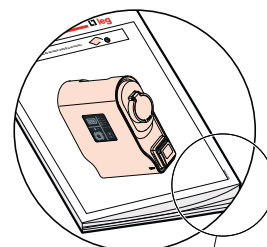

**LE09745AA**

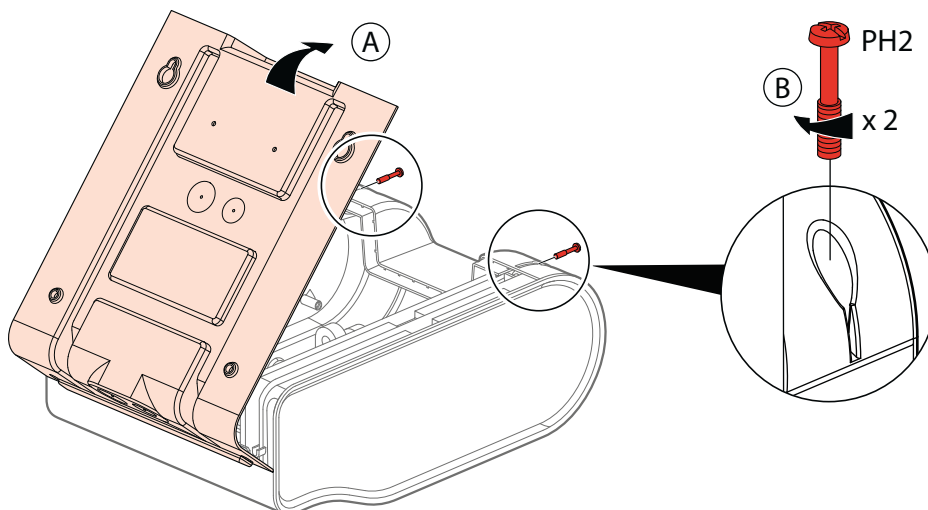





Stellen Sie vor der Inbetriebnahme sicher, dass die Stromversorgung unterbrochen ist.  
Halten Sie sich strikt an die Gebrauchs- und Installationsanweisungen.

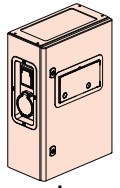

+  
0 590 56

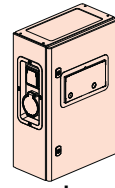
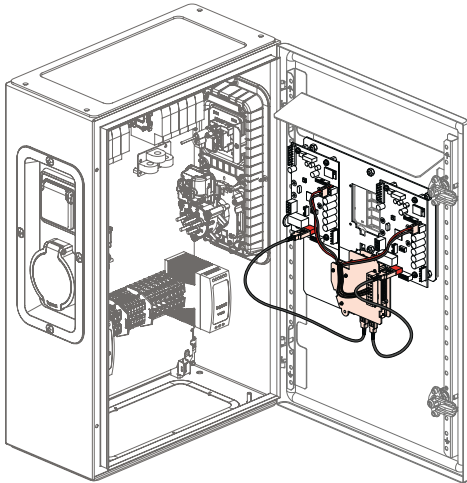

+  
0 590 56

+  
0 590 59 **I**

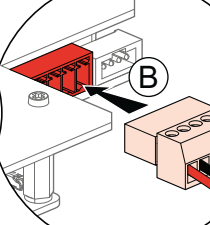
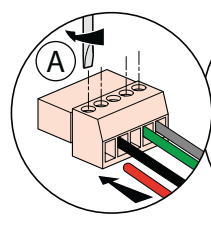
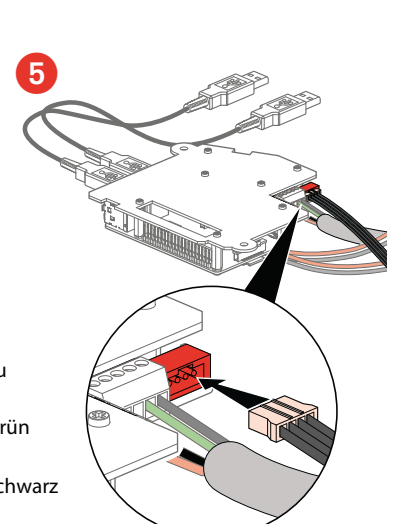
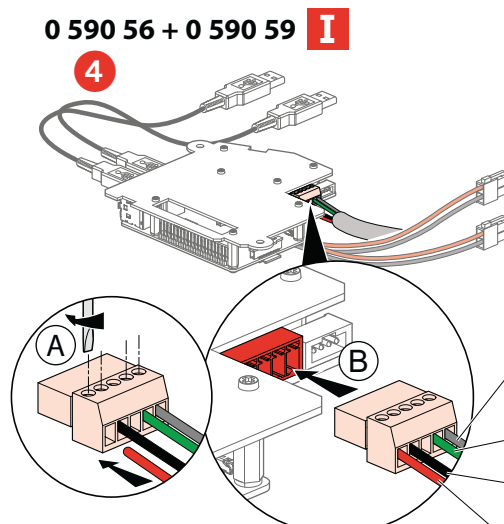
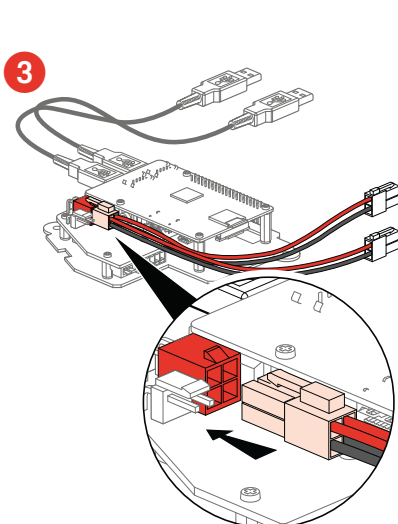
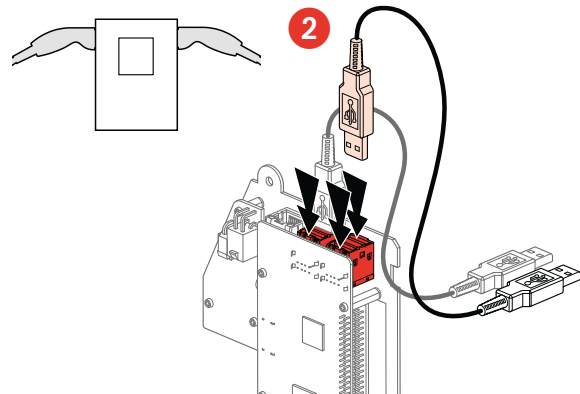
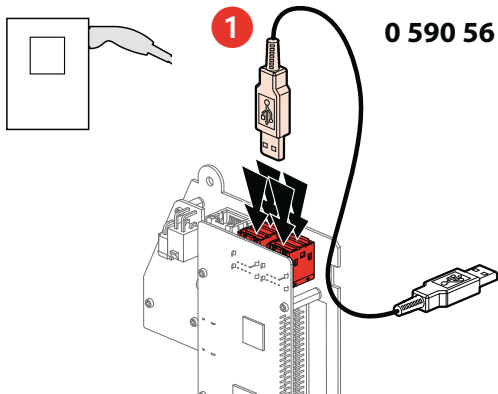
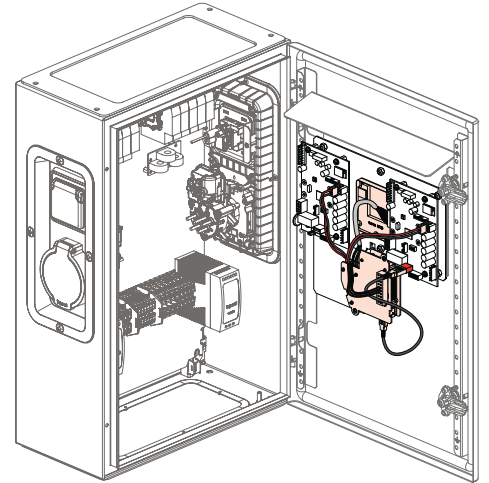

Grau  
Grün  
Schwarz  
Rot



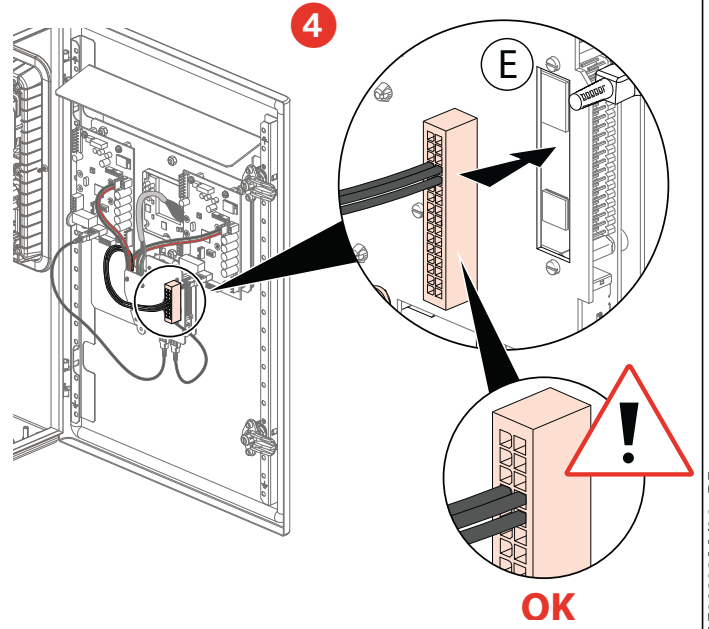
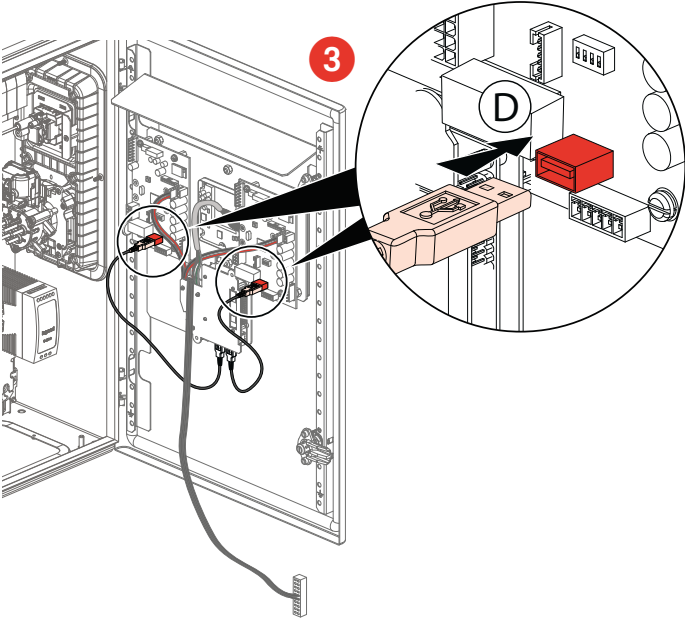
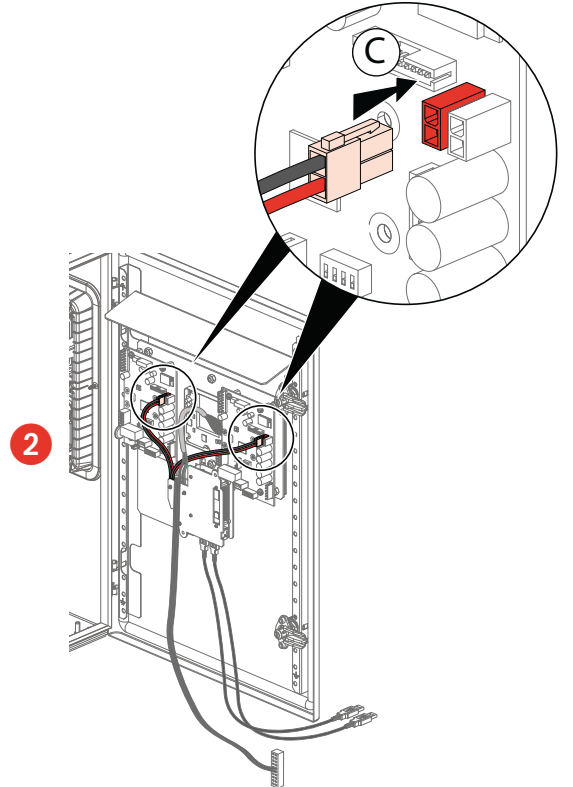
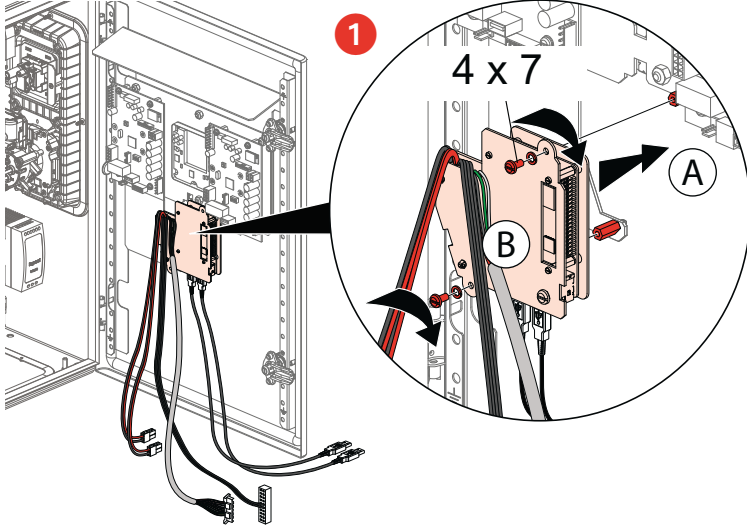

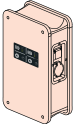

+ 0 590 59 **I**

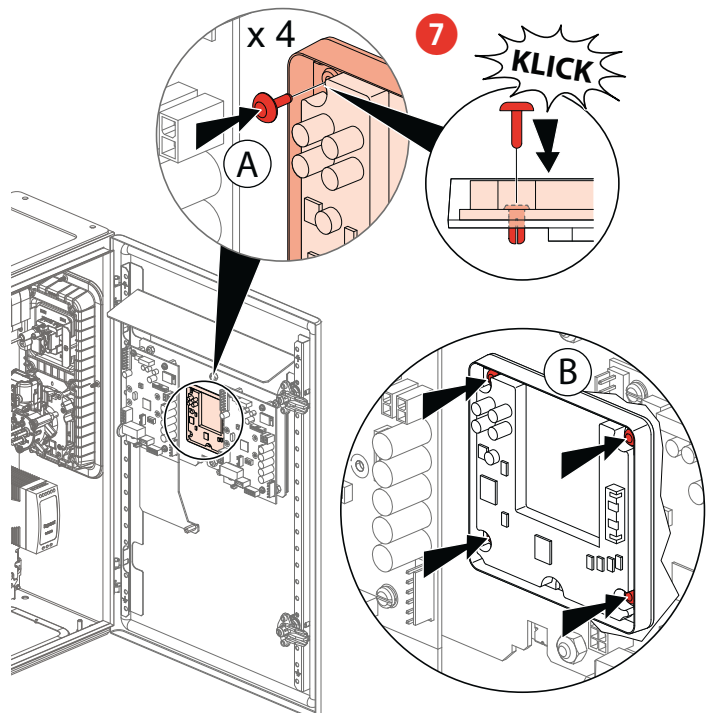
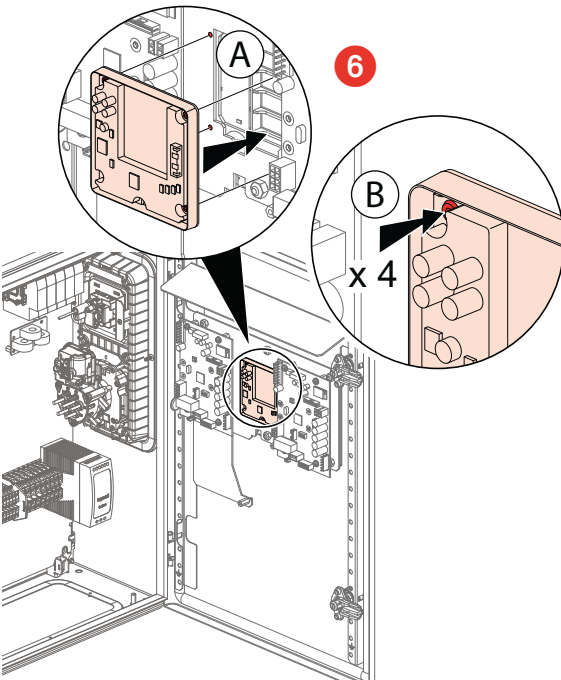
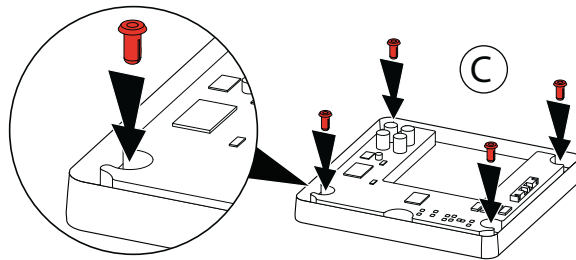
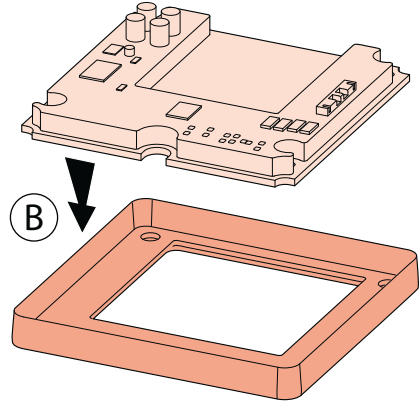
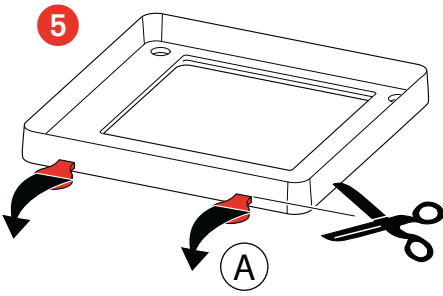

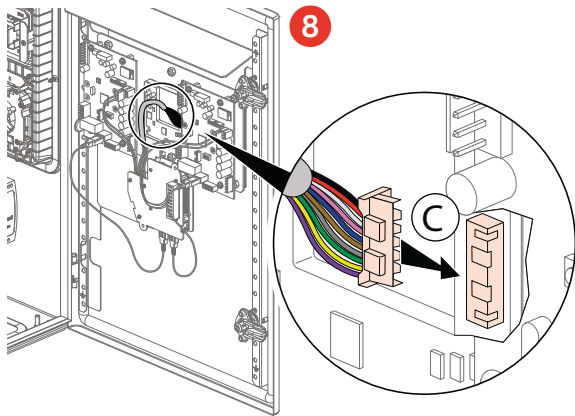

Der Unterzeichnete, LEGRAND, erklärt, dass die Funkanlage des Typs (0 590 56/59) den Anforderungen der Richtlinie 2014/53/EU entspricht. Den vollständigen Text der EU-Konformitätserklärung finden Sie auf: [www.legrand.com](http://www.legrand.com)

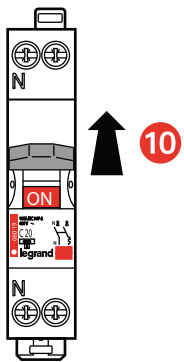
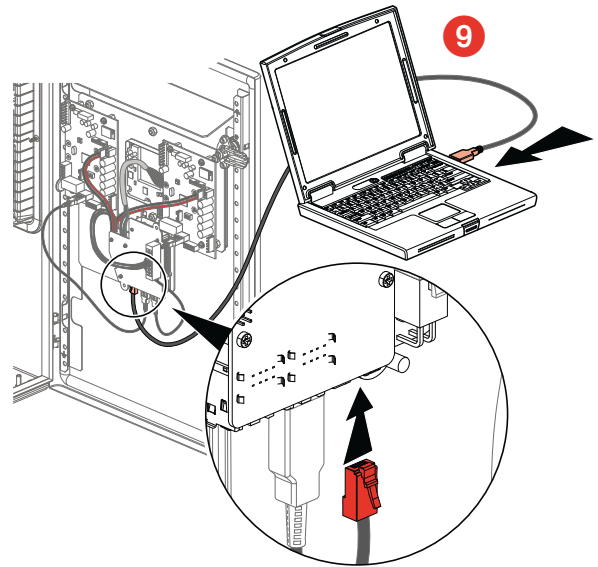

**11** Ihre Ladestation wird sich selbst updaten, sobald das Kommunikationskit verbunden wurde. Warten Sie beim Einschalten mindestens 3 Minuten, bevor Sie die Station konfigurieren oder andere Vorgänge ausführen. In diesem Zeitraum wird jede Seite Ihrer Ladestation automatisch zweimal neu gestartet.

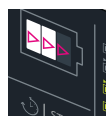

Initialisieren der Ladestation

Weißes Lauflicht und dann konstant weiß leuchtende LEDs  
Warten Sie, dass die Ladestation neu startet und dann



Konstant weiß leuchtende Anzeige – OK

**12**  
Konfiguration siehe Seite 100

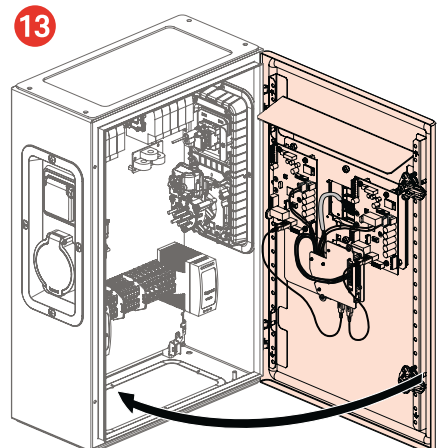



Stellen Sie vor der Inbetriebnahme sicher, dass die Stromversorgung unterbrochen ist.  
Halten Sie sich strikt an die Gebrauchs- und Installationsanweisungen.

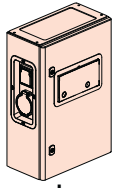

+  
0 590 56

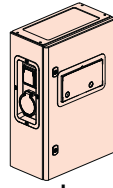
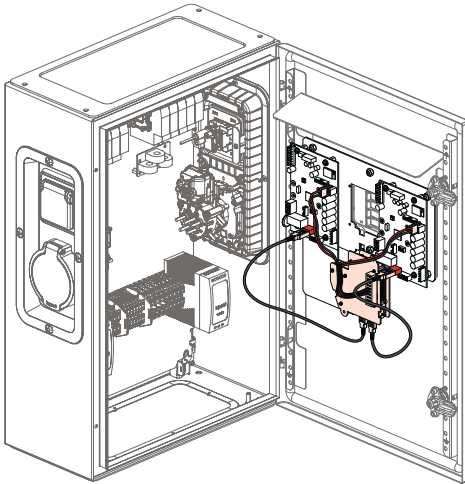

+  
0 590 56  
+  
0 590 59 **II**

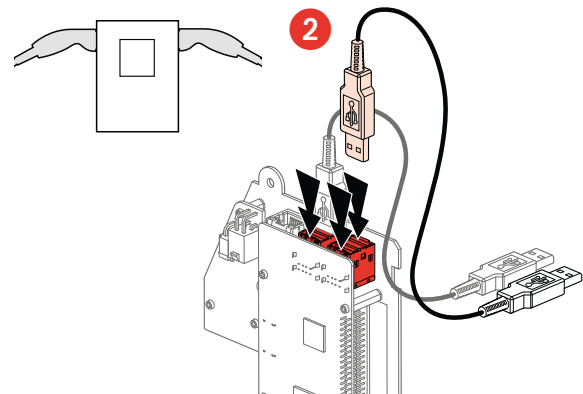
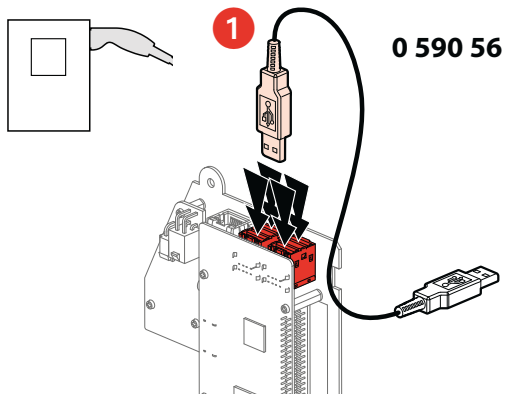
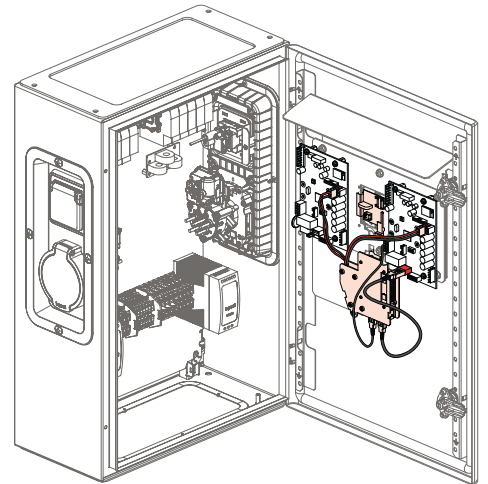

**3** 0 590 56 + 0 590 59 **II**

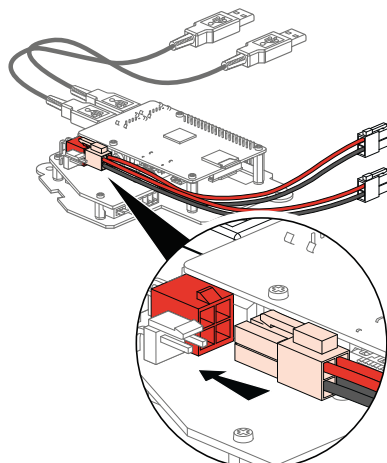

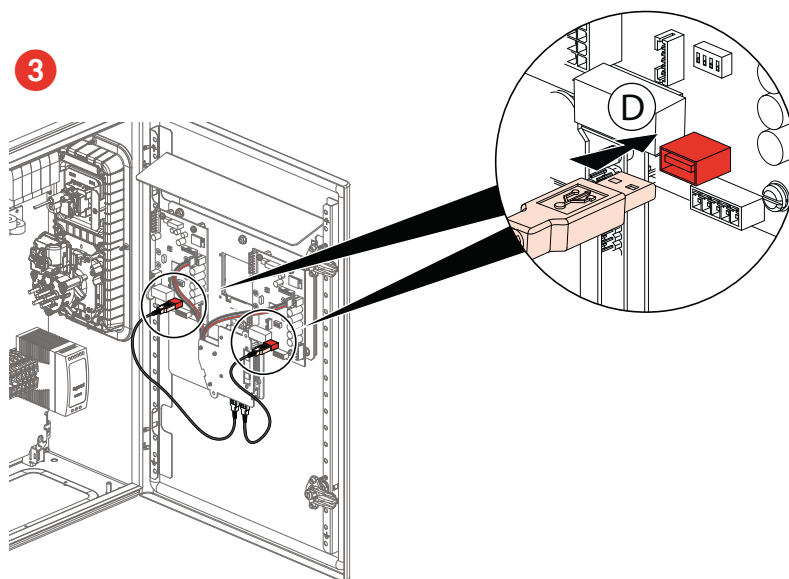
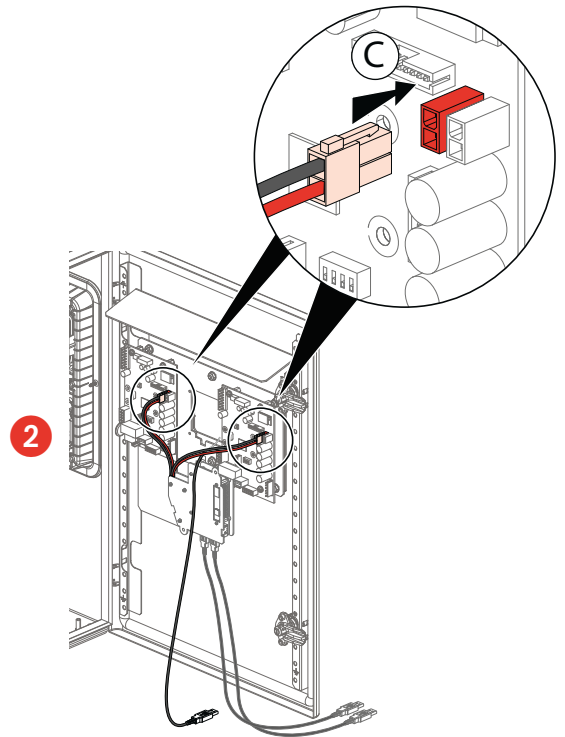
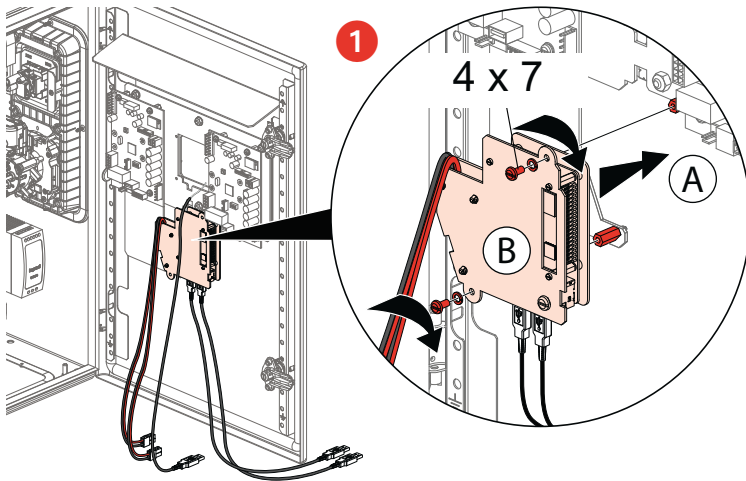



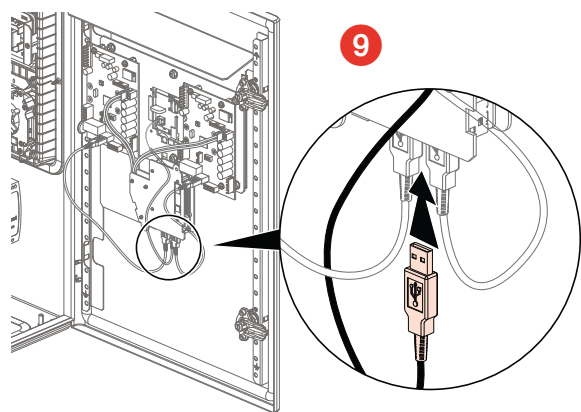
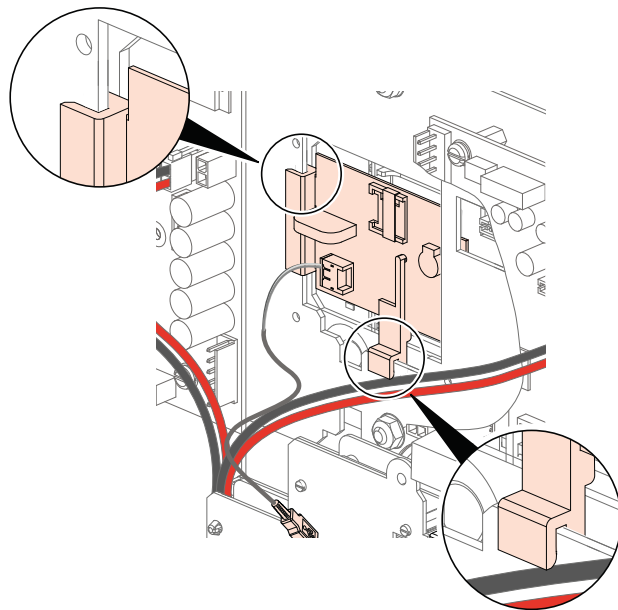
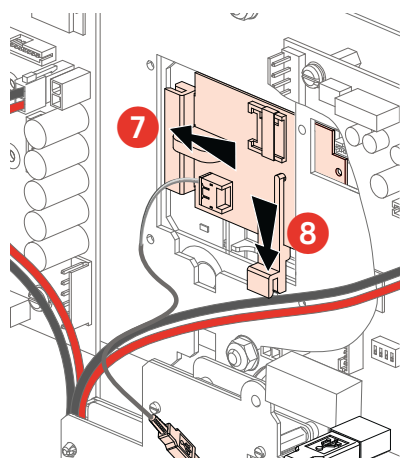
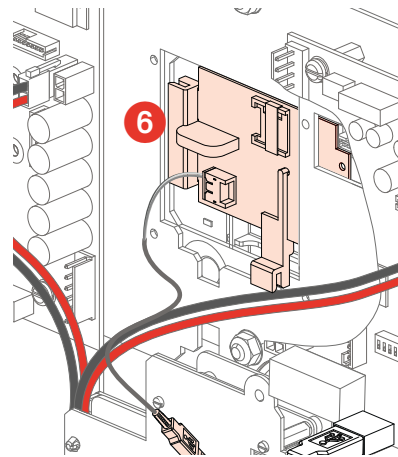
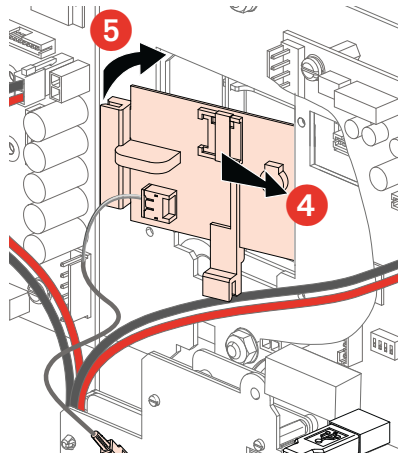

Der Unterzeichnete, **LEGRAND**, erklärt, dass die Funkanlage des Typs (0 590 56/59) den Anforderungen der Richtlinie 2014/53/EU entspricht. Den vollständigen Text der EU-Konformitätserklärung finden Sie auf: [www.legrand.com](http://www.legrand.com)

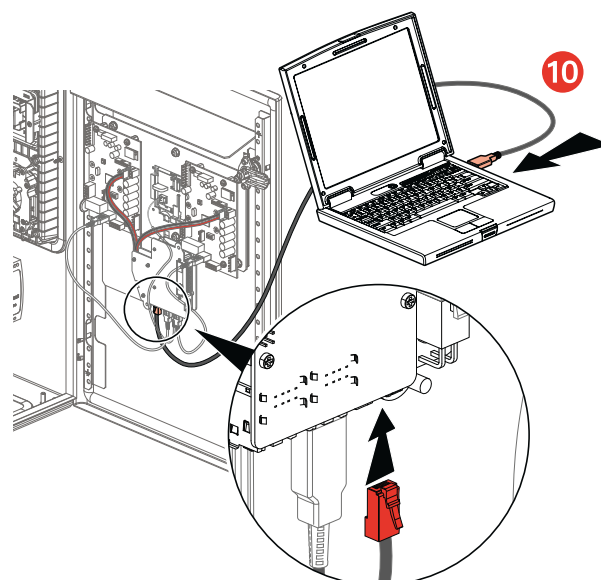

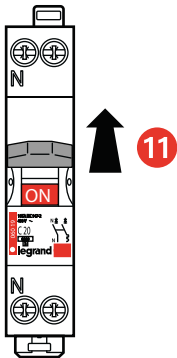

12

Ihre Ladestation wird sich selbst updaten, sobald das Kommunikationskit verbunden wurde. Warten Sie beim Einschalten mindestens 3 Minuten, bevor Sie die Station konfigurieren oder andere Vorgänge ausführen. In diesem Zeitraum wird jede Seite Ihrer Ladestation automatisch zweimal neu gestartet.



Initialisieren der Ladestation

Weißes Lauflicht und dann konstant weiß leuchtende LEDs  
Warten Sie, dass die Ladestation neu startet und dann



Konstant weiß leuchtende  
Anzeige – OK

13

Konfiguration siehe Seite 100

14

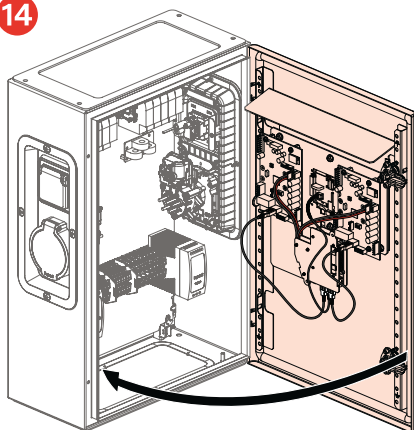



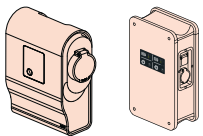
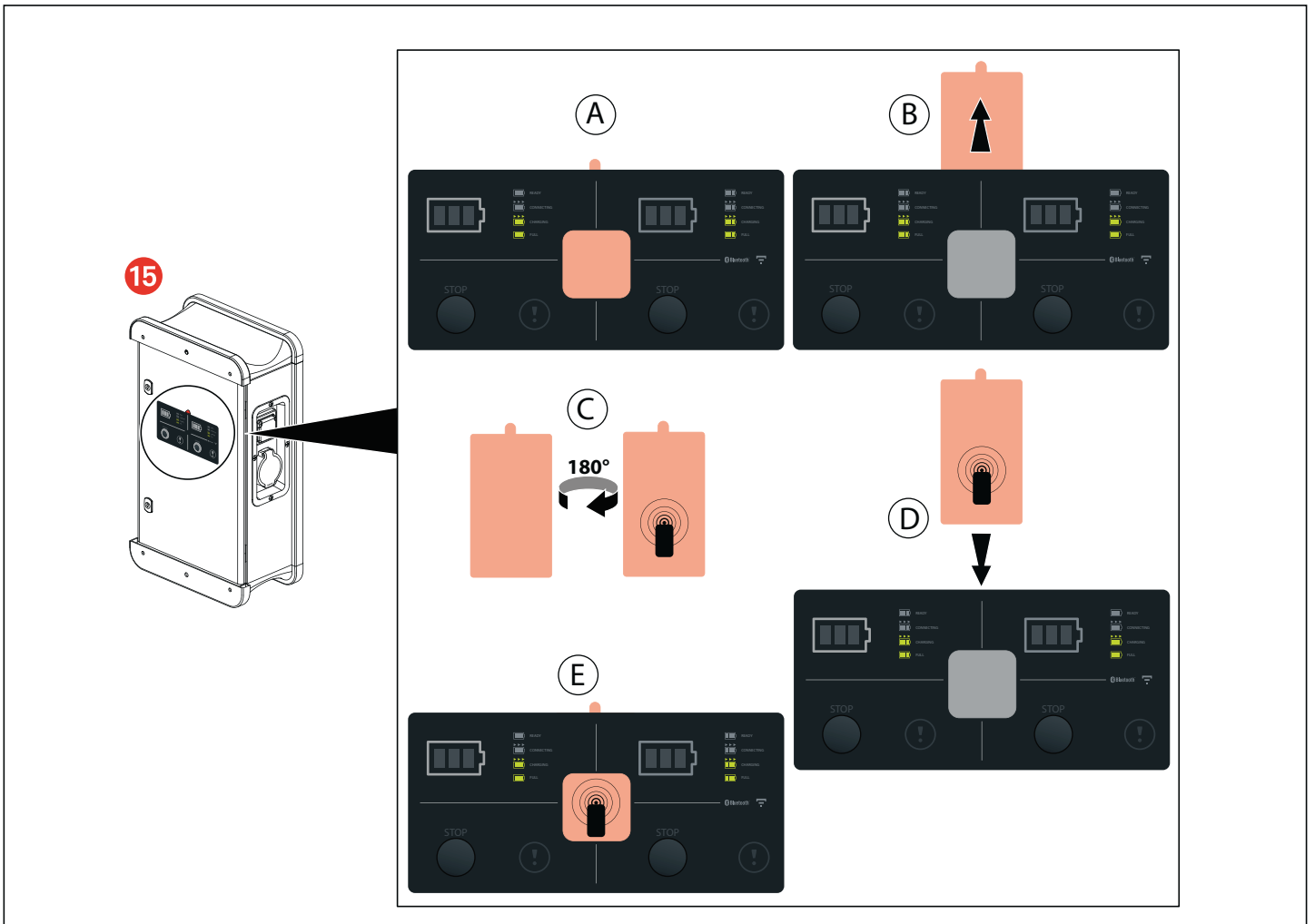

**ANSCHLUSS 0 590 56/59**

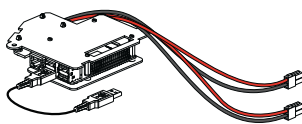
Bestell- Nr.	Webseitenverwaltung	EV-Ladeapp	Modbus	OCPP
<b>0 590 56</b> 	<b>RJ 45 oder WIFI</b>	<b>RJ 45 oder WIFI</b>	<b>RS 485</b>	<b>RJ 45</b>

## ANSCHLUSSSCHALTBILD RJ 45

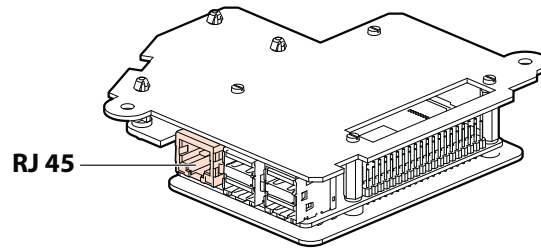

## ANSCHLUSSSCHALTBILD RS485

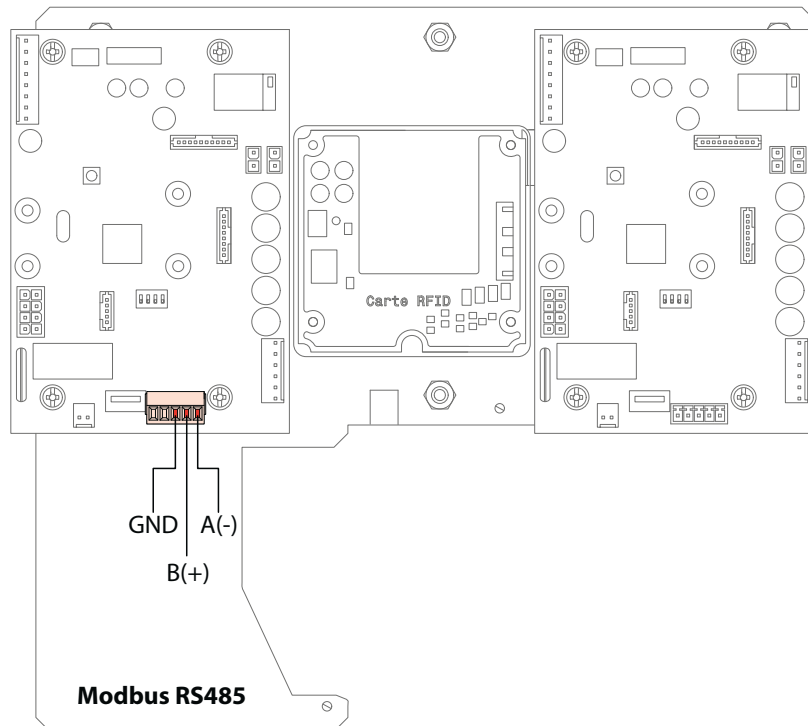

## KONFIGURATION ZUGANG ZU DEN WEBSEITEN

Für IP-, Modbus- und RFID-Konfiguration

- 1) Verbinden Sie den PC in der LAN-Konfiguration über das RJ 45-Kabel mit dem Kommunikationskit.
- 2) Konfigurieren Sie ein lokales Netzwerk.
  - a) im Netzwerk oder Freigabezentrum  
(klicken Sie auf den Start-Knopf (Logo im Handbuch LE08734AA-00) und geben Sie „network and sharing centre“ (Netzwerk und Freigabezentrum) in der Suchleiste ein.)
  - b) Klicken Sie auf „Local Area Connection“ (Ortsgebietverbindung)
  - c) Klicken Sie auf „Properties“ (Eigenschaften)
  - d) Klicken Sie auf „Internetprotokoll Version 4 (TCP/IPv4)“.
  - e) Klicken Sie auf „Properties“ (Eigenschaften)
  - f) Klicken Sie auf „Use the following IP address“  
(Die folgende IP-Adresse verwenden)  
**IP-Adresse: 192.168.1.199**  
**Subnetzmaske: 255.255.255.0**  
**Standardgateway: 192.168.1.1**  
Geben Sie Adresse, Mask und Gateway ein
  - g) Klicken Sie auf „OK“.
  - h) Öffnen Sie den Browser und geben Sie die Adresse ein IP 192.168.1.200

3) Anmelde-Bildschirm

- a) Erstanmeldung (voreingestellter Benutzername und Passwort)

**Benutzer-ID: admin**

**Passwort: admin**

4) Aus Sicherheitsgründen sollten Sie das Passwort ändern.

Benutzer-ID:

Passwort:

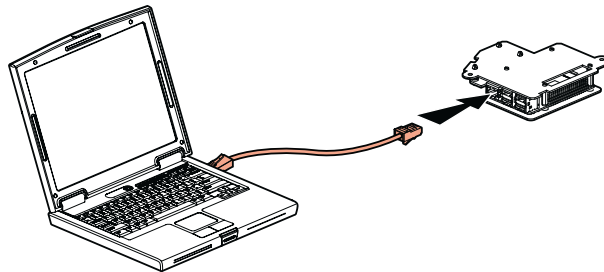

### Startbildschirm





**SCHLÜSSEL:**

**1- Dashboard**

Zeigt Ihnen den Betriebsstatus für jede Seite der Ladestation

**2- Network (Netzwerk)**

Ermöglicht Ihnen, ein kabel- oder drahtloses Netzwerk (WLAN) zu konfigurieren

**3- Charging mode (Lademodus)**

Ermöglicht Ihnen, den Lademodus für jede Seite der Ladestation auszuwählen

**4- Programs (Programme)**

Ermöglicht Ihnen, das Timer-Programm für jede Seite der Ladestation zu verwalten

**5- Settings actions (Einstellvorgänge)**

Ermöglicht Ihnen, fernbedient Aktionen an der Ladestation durchzuführen (Helligkeit, Sperrung, Ladevorgang anhalten, etc.)

**6- RFID**

Ermöglicht Ihnen:

- die RFID-Funktion zu aktivieren (mit Bestell- Nr. 0 590 59)
- Keycards zu verwalten
- den Betriebsmodus zu verwalten: örtlich- oder fernbedient

**7- History (Verlauf)**

Ermöglicht Ihnen, die Lade- und Fehlerprotokolle für jede Seite der Ladestation herunterzuladen

**8- Information/Updates (Informationen/Updates)**

Ermöglicht Ihnen, die Ladestationsysteminformationen zu prüfen (Softwareversion und Hardware)

**Laden Sie sich vor der Inbetriebnahme die Betriebsanleitung von [www.legrand.com](http://www.legrand.com) herunter und installieren Sie das neueste Update unseres Kommunikationskits.**

**1. Örtliche Registrierung der Keycard in der Ladestation**

Stellen Sie die Verbindung mit dem Kommunikationskit her:

Öffnen Sie die Registerkarte „RFID“.

Aktivieren Sie das RFID-Lesegerät.



Wählen Sie „Local Mode“ (Lokaler Modus) aus.



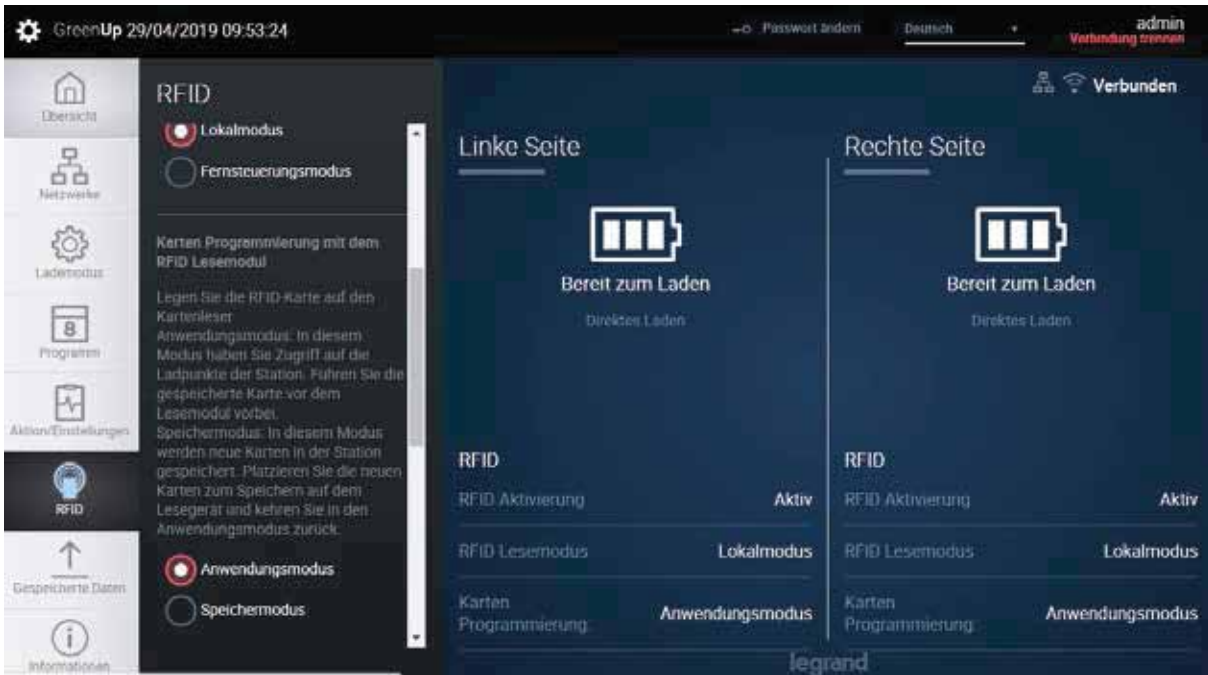

Wählen Sie „Remote Mode“ (Fernsteuerungsmodus) aus.

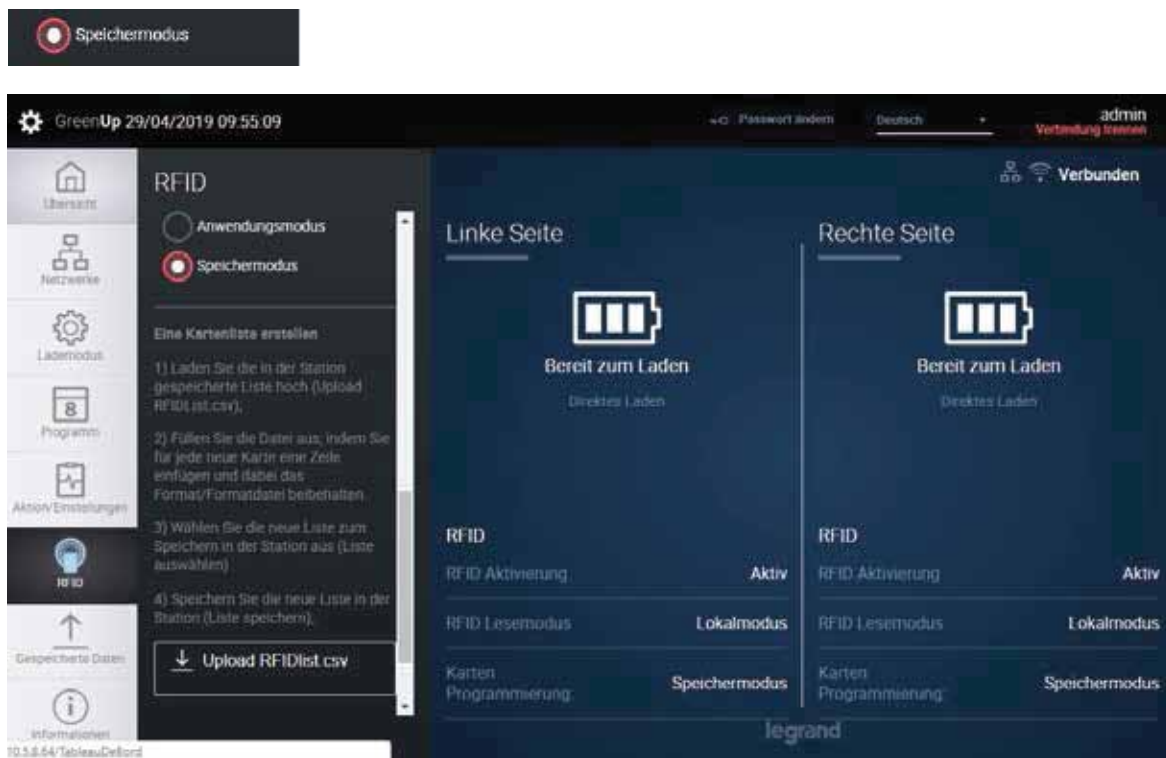

Stellen Sie sich als nächstes vor die Ladestation: weißes Lauflicht auf der Schnittstelle  
 ⇒ Die Ladestation ist bereit zur Registrierung von Keycards  
 Ziehen Sie die Keycard, die registriert werden soll, vor das RFID-Lesegerät: grünes Lauflicht  
 ⇒ Die Keycard ist registriert  
 Wiederholen Sie diesen Vorgang für jede zu registrierende Keycard  
 Um die Registrierung der Keycard abzuschließen gehen Sie zum Betriebsmodus zurück

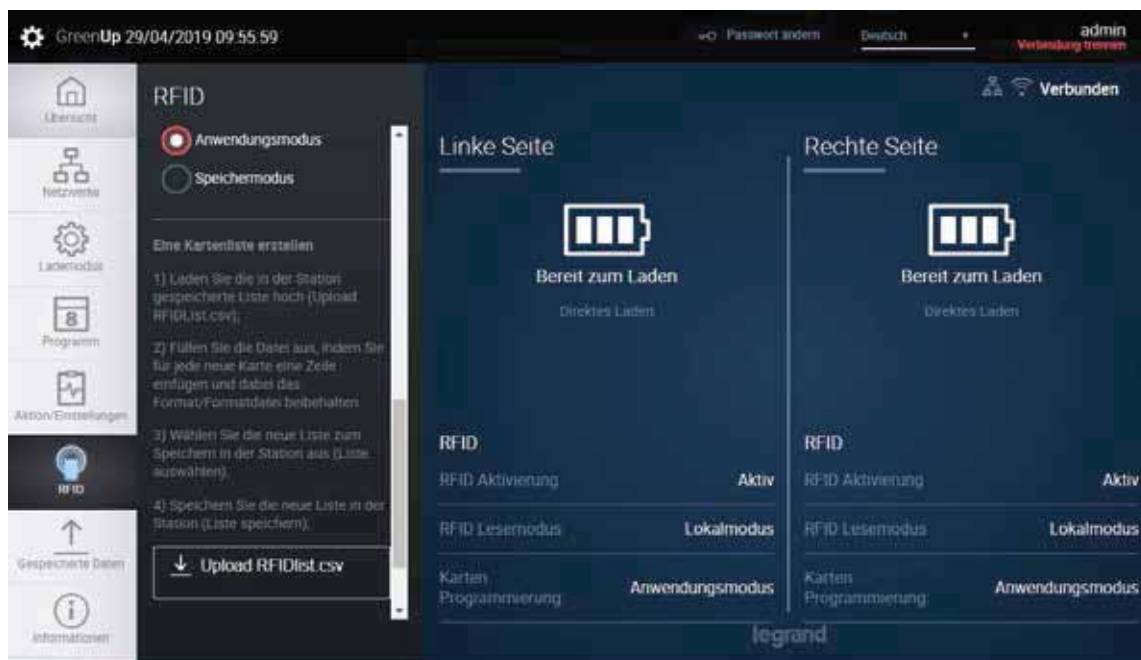

**Hinweis:** Wird eine bereits registrierte Keycard vor die Ladestation durchgezogen, erleuchtet ein rotes Licht

## 2. Eine Keycard-Liste erstellen und verwenden.

Stellen Sie die Verbindung mit dem Kommunikationskit her:  
 Öffnen Sie die Registerkarte „RFID“.  
 Aktivieren Sie das RFID-Lesegerät.



Wählen Sie „Local mode“ aus

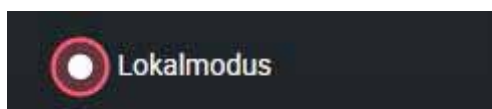

Wählen Sie „Storing mode“ aus

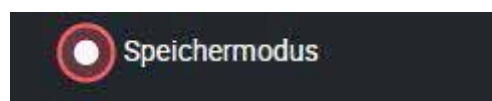

Beispiel für eine Keycard-Liste:

Beachten Sie strikt das folgende Format  
(Datumsangaben und Namen sind optional):

Datum	ID	Name
26/02/2018 08:40	2000236672	Dupont
26/02/2018 08:39	2000243520	Durand
26/02/2018 08:39	1997833664	Martin

Ende

a) Eine Keycard-Liste erstellen:

- Erstellen Sie eine Datei mit dem Namen „RFIDList.csv“ gemäß den obenstehenden Bedingungen.
- geben Sie die Keycard-Daten ein und wo zutreffend die dazugehörigen Namen und Daten
- Klicken Sie auf „+ ADD a tag list“ (+ Kartenliste hinzufügen), um sie auszuwählen.

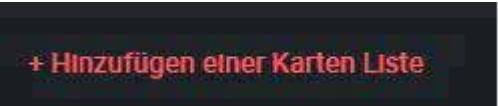

- Klicken Sie auf „RFIDList.csv hochladen“

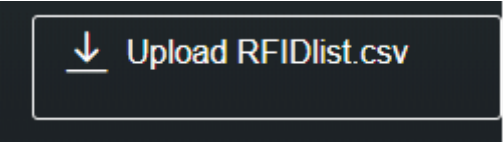

⇒ Ihre Keycard-Liste wurde gespeichert

b) Eine Keycard-Liste bearbeiten

- Klicken Sie auf „RFIDList.csv hochladen“

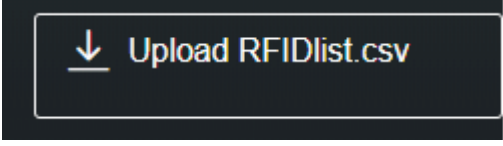

c) Eine Keycard-Liste abwandeln

- Klicken Sie auf „RFIDList.csv speichern“

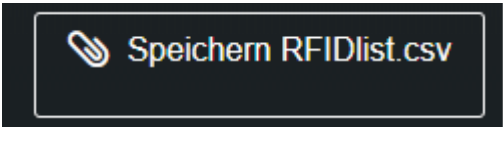

- Nehmen Sie Ihre Änderungen in der Datei vor.  
(Hinzufügungen, Löschungen, Änderung des Benutzers)

- Speichern Sie Ihre Änderungen.

- Klicken Sie auf „Choose file“ (Datei auswählen), um sie auszuwählen.

- Klicken Sie auf „RFIDList.csv speichern“

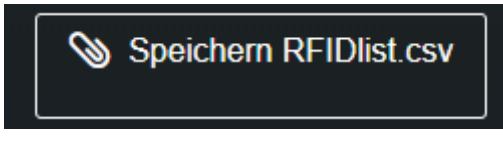

⇒ Ihre neue Keycard-Liste wurde gespeichert



### 3. Nutzen Sie das Schlüsselkartenlesegerät mit zentralisierter Verwaltung.

Stellen Sie die Verbindung mit dem Kommunikationskit her:

Öffnen Sie die Registerkarte „RFID“.

Aktivieren Sie das RFID-Lesegerät.

Wählen Sie den „Remote-Modus“ aus.  
(über das Wiegand-Kommunikationsprotokoll).

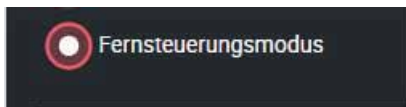

### 4. Die Ladestation mit RFID-Keypcards verwenden

Aktivieren Sie das RFID-Lesegerät.



Wechseln Sie auf der Registerkarte „RFID“ zu „Using Mode“ (Betriebsart).

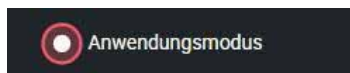

- a) Schließen Sie Ihr Kabel an die Ladestation an.  
Die Keycard vor die Ladestation durchziehen  
Das weiße Licht leuchtet auf der Kabelseite auf => Ladevorgang startet
- b) Ziehen Sie Ihre Keycard vor die Ladestation durch  
Ein grünes Licht blinkt auf  
Schließen Sie Ihr Kabel an (maximale Dauer:  
1 Minute, ziehen Sie die Keycard vor die Ladestation nach einer Minute erneut durch)

### 5. Charging starts

#### Nicht-registrierte Keycard

Falls eine nicht-registrierte Keycard vor die Ladestation durchgezogen wird:  
Rotes Licht blinkt auf

Downloaden von  
[www.legrand.com](http://www.legrand.com)  
LE10817AA-01 (FR)  
LE10990AA-01 (EN)

**GREENUP PREMIUM-LADESTATIONEN**  
Bedienungsanleitung  
Kommunikationskit & RFID-Lesegerät

