

NILOÉ STEP

8 640 01 / 03 / 05 / 06 / 07 / 08 / 11 / 12 / 16 / 30 / 31, 8 641 13,
8 643 13, 8 645 13, 8 646 13

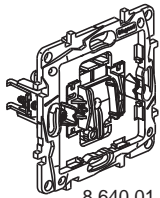

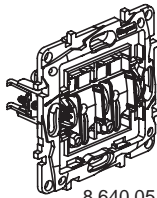

8 640 01 / 06 / 11 / 16

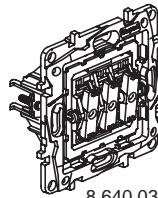

8 640 05 / 08 / 12



8 640 03

 	
-10°C ... +70°C	-5°C ... +40°C

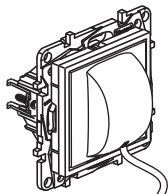

8 641 13
8 643 13
8 645 13
8 646 13

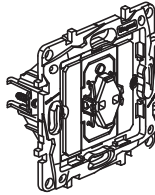

8 640 30

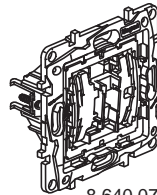

8 640 07

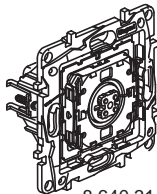
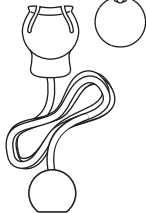

8 640 31

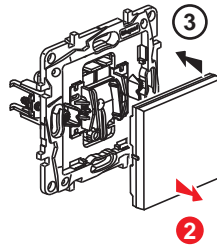

2

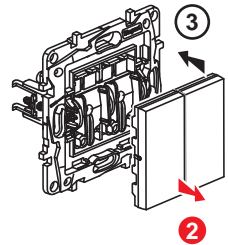

2

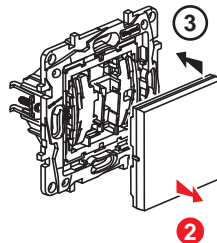

2

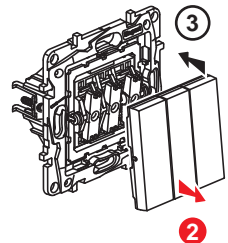

2

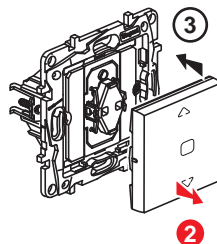

2

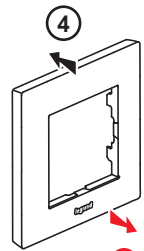

1

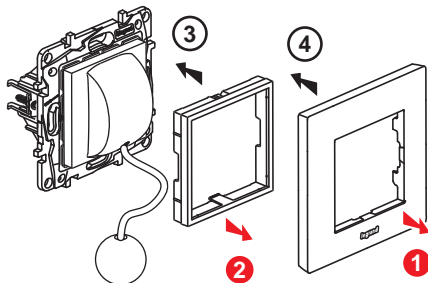

2

1

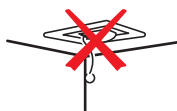
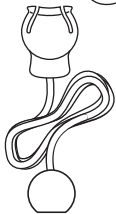

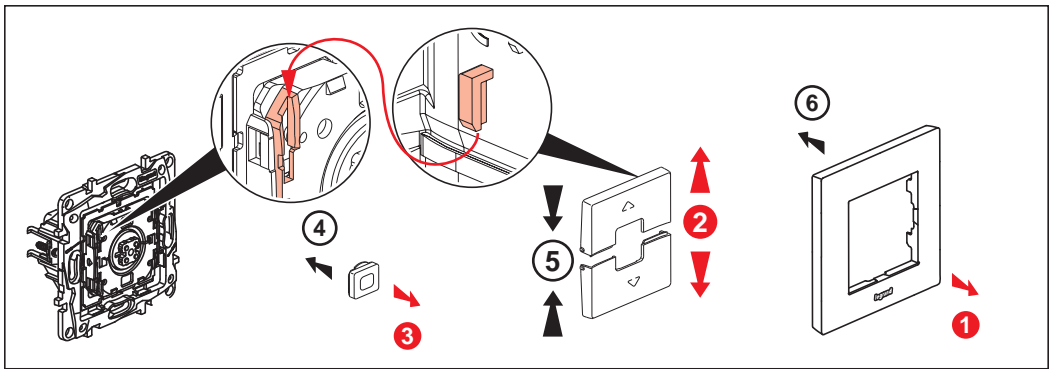

8 640 01

10 AX - 250 V~

≤ 2,5 mm²

13 mm

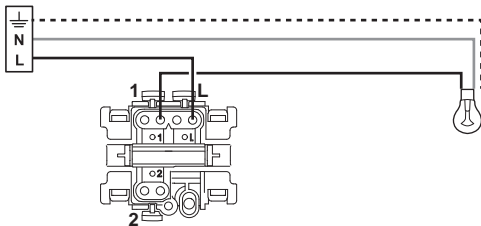

8 640 03

10 AX - 250 V~

≤ 2,5 mm²

10 mm

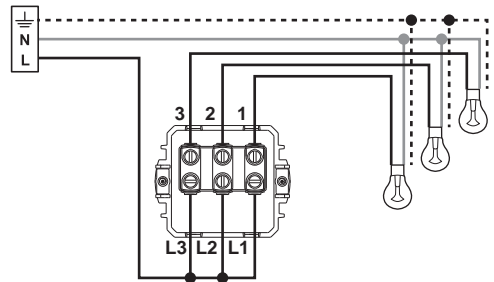

8 640 05

10 AX - 250 V~

≤ 2,5 mm²

13 mm

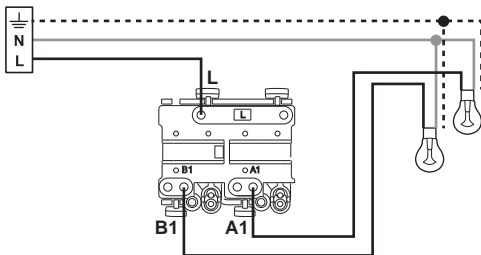

8 640 06 / 16

10 / 16 AX - 250 V~

≤ 2,5 mm²

13 mm

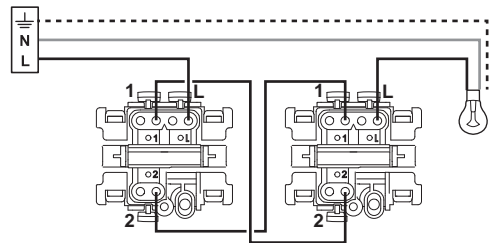

8 640 07

10 AX - 250 V~

≤ 2,5 mm²

13 mm

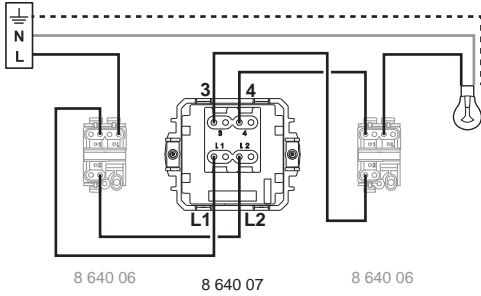

8 640 08

10 AX - 250 V~

≤ 2,5 mm²

13 mm

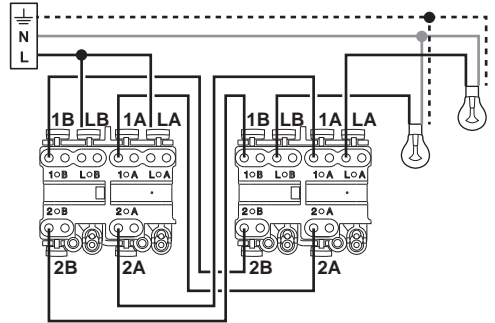

8 640 11

6 A - 250 V~

≤ 2,5 mm²

13 mm

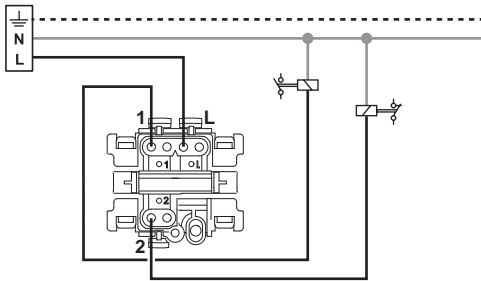

8 640 12

6 A - 250 V~

≤ 2,5 mm²

13 mm

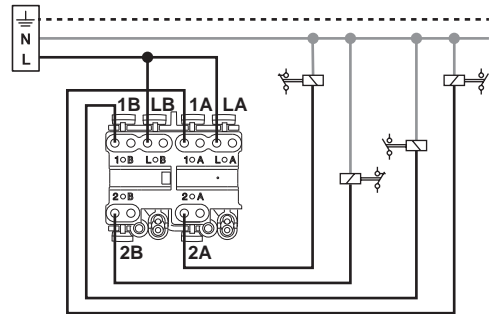

8 640 30

6 A - 250 V~

≤ 2,5 mm²

8 mm

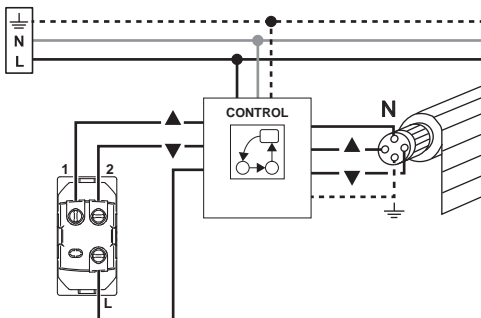

8 640 31



6 AX - 250 V~

≤ 2,5 mm²

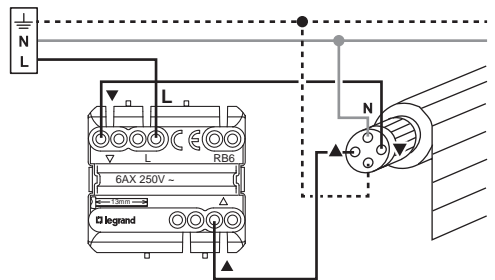
13 mm



8 641 13
8 643 13
8 645 13
8 646 13

6 A - 250 V - m	
	≤ 2,5 mm ²
	12 mm

