

		Control	Return Path	Channel 1	Channel FM	Channel VHF	Channel UHF	Channel SAT (IF)
75 Ω	500 mA	22 kHz 0,6 V	4 - 30 MHz	47 - 68 MHz	87,5 - 108 MHz	120 - 470 MHz	470 - 862 MHz	950 - 2400 MHz
8 640 50 8 649 50		1,5 dB		1,5 dB				2 dB

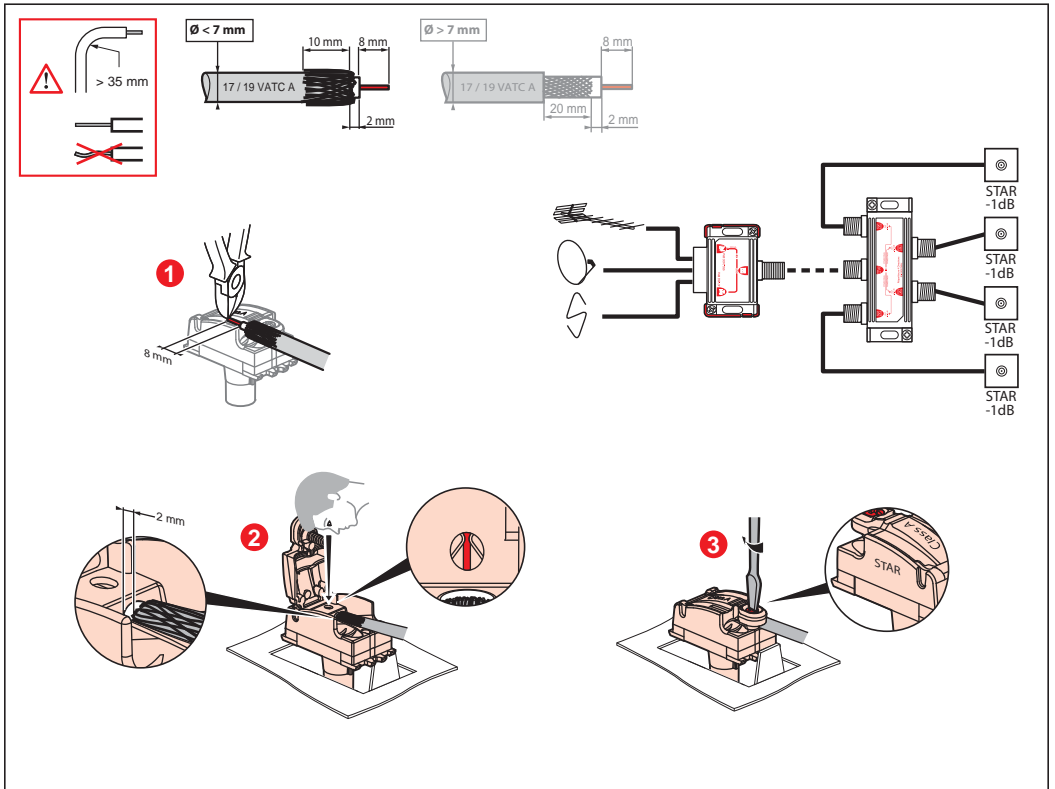

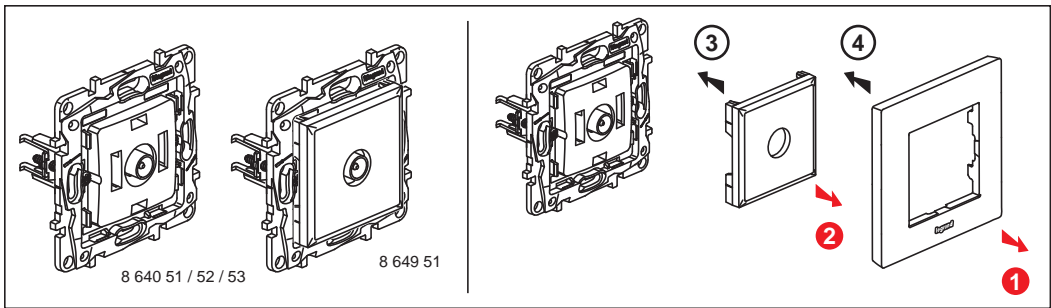

Z	Control	Return Path	Channel 1	Channel FM	Channel VHF	Channel UHF	Channel SAT (IF)	
75 Ω	500 mA	22 kHz 0,6 V	4 - 30 MHz	47 - 68 MHz	87,5 - 108 MHz	120 - 470 MHz	470 - 862 MHz	950 - 2400 MHz
8 640 51 8 649 51	1,5 dB	1,5 dB					2 dB	
8 640 52		14 dB						
8 640 53		10 dB						

> 35 mm

$\varnothing < 7 \text{ mm}$

$\varnothing > 7 \text{ mm}$

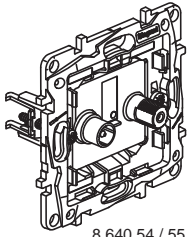

8 640 54 / 55 / 56

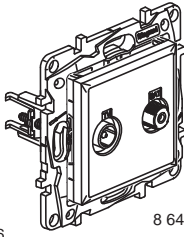

8 649 54

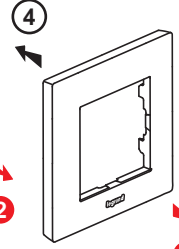
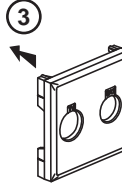
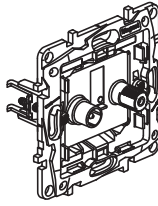

1

Control	Return Path	Channel 1	Channel FM	Channel VHF	Channel UHF	Channel SAT (IF)				
Z	—	75 Ω	500 mA	22 kHz 0,6 V	4 - 30 MHz	47 - 68 MHz	87,5 - 108 MHz	120 - 470 MHz	470 - 862 MHz	950 - 2400 MHz
8 640 54, 8 649 54		1,5 dB		2 dB						
8 640 55		1,5 dB		14 dB						
8 640 56		10 dB								

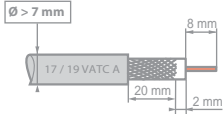
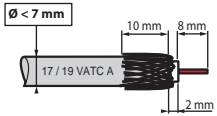
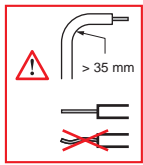

TV-SAT	8 640 54 8 649 54	8 640 55	8 640 56

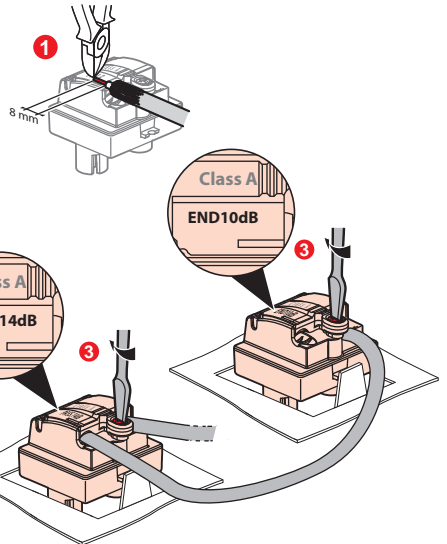
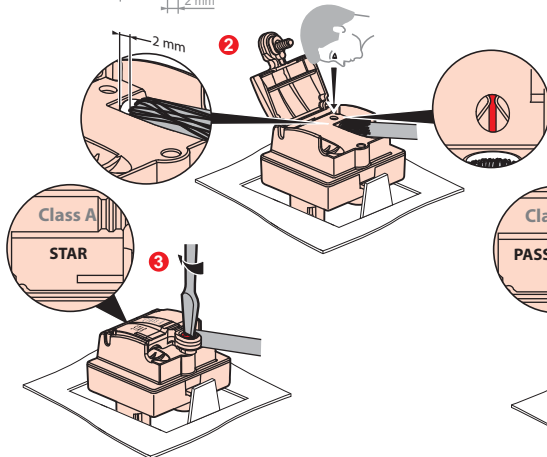

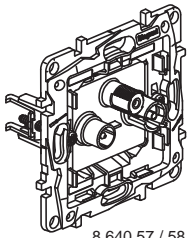

8 640 57 / 58 / 59

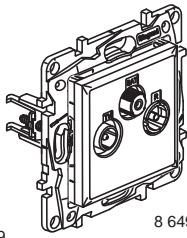

8 649 57

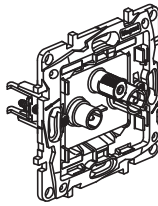



3

4

2

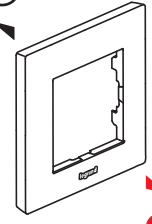
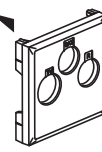
1



 		Control	Return Path	Channel 1	Channel FM	Channel VHF	Channel UHF	Channel SAT (IF)	
Z	—								
75 Ω	500 mA	22 kHz 0,6 V	4 - 30 MHz	47 - 68 MHz	87,5 - 108 MHz	120 - 470 MHz	470 - 862 MHz	950 - 2400 MHz	
8 640 57, 8 649 57		1,5 dB	1,5 dB					2 dB	
8 640 58			14 dB						
8 640 59			10 dB						

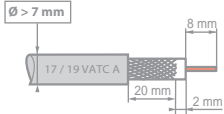
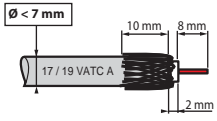
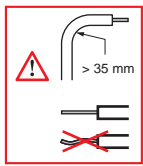

TV-R-SAT	8 640 57 8 649 57	8 640 58	8 640 59
