

Control	Return Path	Channel 1	Channel FM	Channel VHF	Channel UHF	Channel SAT (IF)				
 Z	 —	75 Ω	500 mA	22 kHz 0,6 V	4 - 30 MHz	47 - 68 MHz	87,5 - 108 MHz	120 - 470 MHz	470 - 862 MHz	950 - 2400 MHz
8 640 50 8 649 50	1,5 dB	1,5 dB					2 dB			

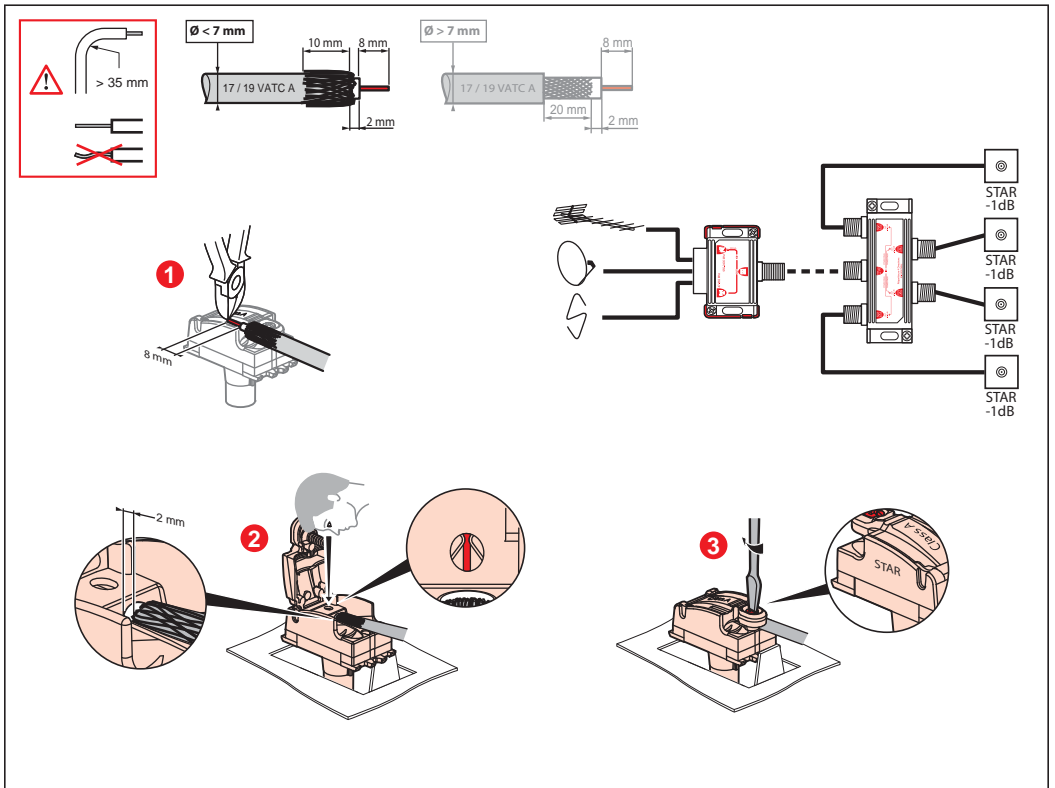

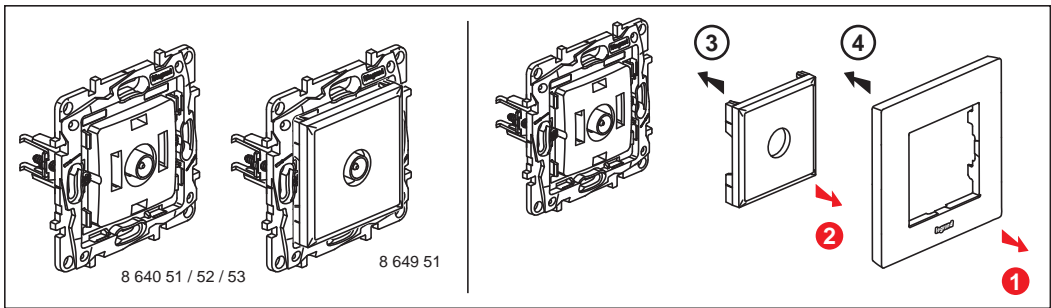

Z	Control	Return Path	Channel 1	Channel FM	Channel VHF	Channel UHF	Channel SAT (IF)	
75 Ω	500 mA	22 kHz 0,6 V	4 - 30 MHz	47 - 68 MHz	87,5 - 108 MHz	120 - 470 MHz	470 - 862 MHz	950 - 2400 MHz
8 640 51 8 649 51	1,5 dB	1,5 dB						2 dB
8 640 52		14 dB						
8 640 53		10 dB						

**Wiring Diagrams:**

- For  $\varnothing < 7\text{ mm}$ : 17/19 VATCA cable with 10mm shield, 8mm core, and 2mm insulation.
- For  $\varnothing > 7\text{ mm}$ : 17/19 VATCA cable with 20mm shield, 8mm core, and 2mm insulation.

**Power and Signal Connections:**

- 230 V power supply connected to a +20dB amplifier.
- Signal path: STAR -1dB → STAR -1dB → STAR -1dB → STAR -1dB → PASS -14dB → END -10dB.

**Assembly Steps:**

- Strip the cable jacket by 8 mm.
- Strip the shield and core by 2 mm.
- Insert the shield into the STAR component, the core into the PASS component, and the remaining insulation into the END component.

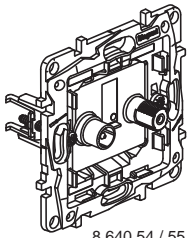

8 640 54 / 55 / 56

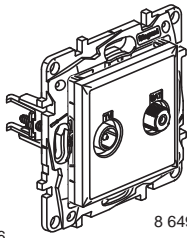

8 649 54

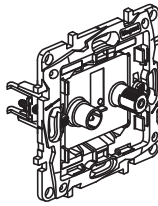

3

4

2

1

		Control	Return Path	Channel 1	Channel FM	Channel VHF	Channel UHF	Channel SAT (IF)	
Z	—								
75 Ω	500 mA	22 kHz 0,6 V	4 - 30 MHz	47 - 68 MHz	87,5 - 108 MHz	120 - 470 MHz	470 - 862 MHz	950 - 2400 MHz	
8 640 54, 8 649 54		1,5 dB	1,5 dB					2 dB	
8 640 55			14 dB						
8 640 56			10 dB						

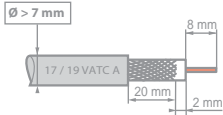
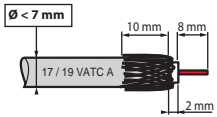
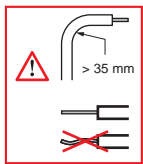

TV-SAT	Model	Diagram
TV-SAT	8 640 54 8 649 54	
	8 640 55	
	8 640 56	

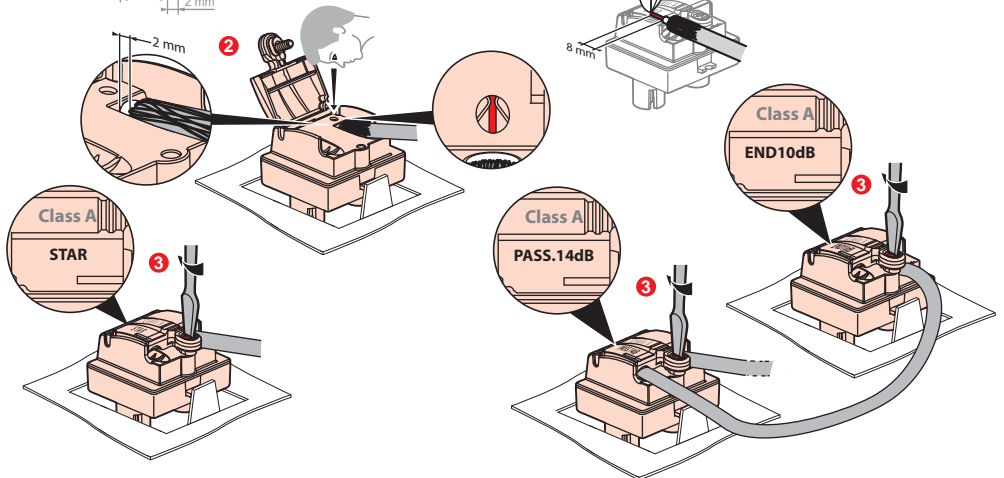

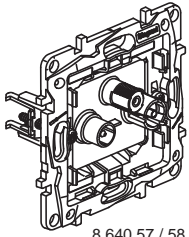

8 640 57 / 58 / 59

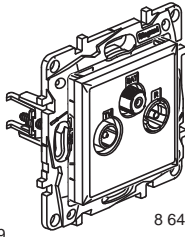

8 649 57

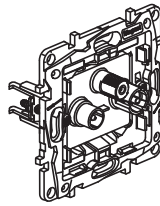



3

4

2

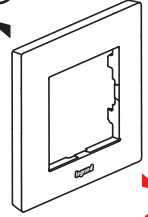
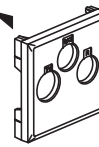
1



 		Control	Return Path	Channel 1	Channel FM	Channel VHF	Channel UHF	Channel SAT (IF)
Z	—							
75 Ω	500 mA	22 kHz 0,6 V	4 - 30 MHz	47 - 68 MHz	87,5 - 108 MHz	120 - 470 MHz	470 - 862 MHz	950 - 2400 MHz
8 640 57, 8 649 57		1,5 dB	1,5 dB					2 dB
8 640 58			14 dB					
8 640 59			10 dB					

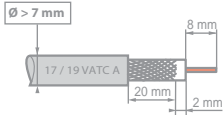
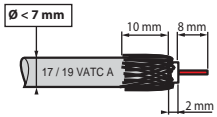
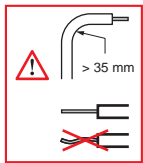

TV-R-SAT	8 640 57 8 649 57	8 640 58	8 640 59
