







8 640 24

 		P	
-10°C ... +70°C	-5°C ... +40°C	250 V~ 5 V~ 2400 mA	 6 mm  2,5 mm <sup>2</sup>



3

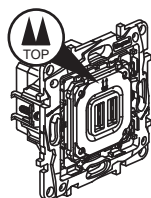
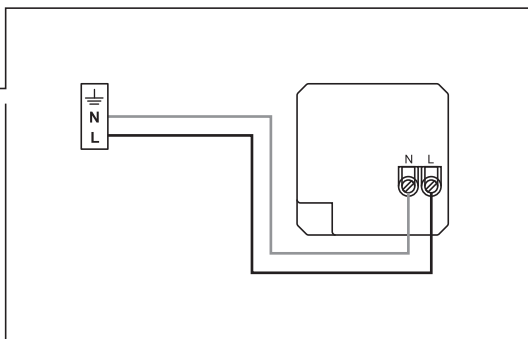
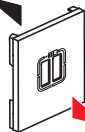

2

4

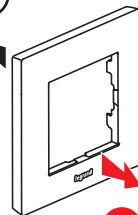

1

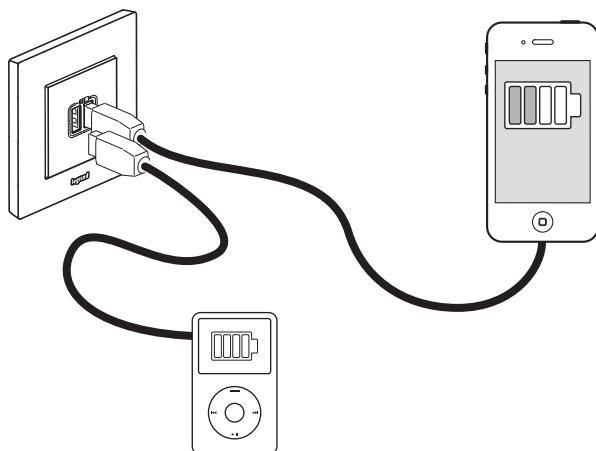

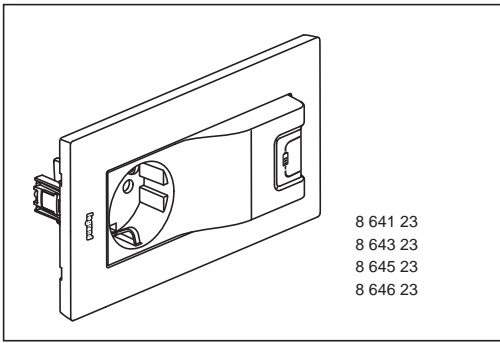

		P	
-10°C ... +70°C	-5°C ... +40°C	16 A 250 V~ 5 V=± 1000 mA	12 mm  2,5 mm <sup>2</sup>

